

EST-275 R 4C 1277 4  
RICHARD B FONES JR  
25 BALTIMORE-ANNAPOLIS  
BLVD-FERNDALE  
GLEN BURNIE MD 21061

April, 1976 □ 75 cents

# Electronic Servicing



A HOWARD W. SAMS PUBLICATION

**UHF:  
taking SNOW  
out of snow**

**Parts Profits  
Or Losses?**

**Rapid Repairs  
Of Portable  
Phonos**

**Newcom '76  
Issue**





**'WHEN I  
STARTED  
USING PTS,  
IT WAS LIKE  
GAINING  
TWO HOURS  
A DAY'**

Ron Baysinger / Service Manager  
Preferred TV / Indianapolis



That's not an uncommon testimonial from hundreds of PTS customers all over the country. Just consider how much time you spend on the average tuner repair in your own shop. That's how much shop time you could gain for each tuner job you turn over to your nearest

PTS Service Center. Taking the tuner repair load outside, frees up inside time for more business and greater income. We can repair most any tuner of the thousands in use, have most repairs ready in one day and guarantee the work for one year.



**ELECTRONICS, INC.**  
PRECISION TUNER SERVICE

Consult the white pages of your telephone directory for the address and number of your nearest PTS Service Center. General Headquarters: Bloomington, IN - Birmingham - Phoenix - Los Angeles - San Diego - San Jose (CA) - Sacramento - Arvada (CO) - Jacksonville - Tampa - Indianapolis - Kansas City (KS) - Metairie (LA) - Silver Spring (MD) - Boston - Springfield (MA) - Detroit - Grand Rapids (MI) - Minneapolis - St. Louis - E. Paterson (NJ) - Buffalo (NY) - Long Island - Charlotte (NC) - Cincinnati - Columbus (OH) - Cleveland - Toledo - Oklahoma City - Portland (OR) - Pittsburgh - Philadelphia - Montreal - Memphis - Houston - Longview (TX) - Salt Lake City - Norfolk - Seattle - Milwaukee.

For More Details Circle (1) or Reply Card



**With a line like this, no wonder  
your Mallory distributor is a yes man.**

He almost never has to say no. Which adds up to a lot of single-source buying convenience for you. Give your Mallory distributor a call. You'll like what you hear. You'll like what he delivers.



**MALLORY DISTRIBUTOR PRODUCTS COMPANY**  
 a division of P. R. MALLORY & CO. INC.  
 Box 1284, Indianapolis, Indiana 46208; Telephone: 317-858-3731  
 ® Registered trademark of P. R. Mallory & Co. Inc.

For More Details Circle (8) on Reply Card



# electronicscanner

news of the industry

---

**NEWCOM**, the super show of electronics, will be held May 4-6 in the new **Superdome at New Orleans**. During NEWCOM each year, thousands of representatives from wholesale distributors will come to see and to order products from hundreds of manufacturers. Although this show is virtually unknown to most service dealers, it is the most important factor determining which products you will buy and use during the next year.

**Chrysler Corporation expects to produce about 300,000 spark-control computers for its 1977 cars.** **Electronic News** reports that 1.2 million ICs (of both C/MOS and bipolar types) will be purchased for the "lean burn" engine computer. This is an analog computer using "hard-wired" logic; each unit has four ICs, and more than 200 components.

**A herring sex sorter is the "Award of Merit" winner of the 1975 Governor General of Canada's award for Engineering Design.** **Canada Courier** says the machine automatically separates roe-bearing females from males and results in about 50 per cent more fish being used beneficially rather than being reduced to fertilizer or waste. It was designed by Hauptmann, Green and Associates Ltd. of North Vancouver, British Columbia. Prior to the development of the automatic sex sorter, both males and females were "firmed" in brine (as roe has to be firmed before removal from the female). The firming process, however, renders the flesh inedible with the result that males, which could have been used for the fresh fillet market, were lost.

**RCA plans to offer a Custom line to department stores, and a Variation line to discount stores.** In broadening the line, RCA will present most 19- and 25-inch screen sizes in ColorTrak models, while the 15-, 17-, and 21-inch sizes will be XL-100 models. **Home Furnishings Daily** also reports that the company shortly will introduce the lowest-priced 19-inch all-solid-state set in its history. RCA confirmed the introduction and said the set would have a suggested price of \$399.

**Geri Ann Atherton**, a truck-driving mother-of-four from Sacramento, California, has been named "Queen of the Road" for 1976 in the annual competition, sponsored by Radio Shack and other companies. Among the prizes awarded to the new Queen was a Realistic telephone-type deluxe CB two-way radio. The Queen of the Road was selected by a committee of judges as the outstanding woman truck driver of the year in North America based on "beauty, intelligence, and ability."

**Most Rockwell-Admiral appliance and electronic parts will be scrapped in the field.** Check with your local Admiral distributor for details.

**Antenna Specialist** was one of three firms to receive the 1975 "Employer of the Year Award" from the National Association for Mental Health and the President's Committee on Employment of the Handicapped. In the past ten months, Vocational Guidance and Rehabilitation Services of Cleveland and Antenna have worked with over 40 mentally-restored individuals, helping them to become readjusted to the world of work. Twenty per cent of the workers at Antenna are persons from local mental-health units and hospitals.

**Sprague Electric Company and the Cabot Corporation are to merge.** Sprague is the largest manufacturer of fixed capacitors in the United States, and also manufactures resistors, thick-film hybrid circuits, filters, magnetic components, transistors, and semiconductor integrated circuits. Both Cabot and Sprague have worldwide operations.

*(Continued on page 6)*

# TUNER SERVICE CORPORATION

**SUBSTITUNER**

JUST

**\$44.95**  
U.S.A. ONLY

WITH CABLES



ONE YEAR  
GUARANTEE

STILL ONLY

**\$9.95**  
U.S.A. ONLY

MAJOR PARTS  
AND SHIPPING  
CHARGED AT COST



## FEATURES

- A UHF Tuner with 70 channels which are detented and indicated just like VHF channels.
- A VHF Hi Gain Solid State Tuner.
- AC Powered • 90 Day Warranty

Demonstrate the **SUBSTITUNER** to your customers and show improved reception with their TV sets.

You may place your order through any of the Centers listed below.

## NEWS FLASH!

NOW AVAILABLE—TUNER SERVICE PARTS CATALOG OF ALL SARKES TARZIAN VHF AND UHF TUNERS, INCLUDING EXPLODED VIEW DRAWINGS. OVER 200 PAGES. ORDER YOUR COPY TODAY. SEND \$2.50 WITH ORDER TO BLOOMINGTON HEAD OFFICE.

PROVIDES YOU WITH A COMPLETE SERVICE FOR ALL YOUR TELEVISION TUNER REQUIREMENTS.

## REPAIR

VHF OR UHF ANY TYPE ..... (U.S.A. ONLY) \$ 9.95  
UHF/VHF COMBINATION ..... (U.S.A. ONLY) \$15.00

MAJOR PARTS AND SHIPPING  
CHARGED AT COST

- Fast, efficient service at our conveniently located Service Centers.
- All tuners are ultrasonically cleaned, repaired, realigned, and air tested.

## REPLACE

UNIVERSAL REPLACEMENT TUNER \$12.95 (U.S.A. only)

- This price buys you a complete new tuner built specifically by Sarkes Tarzian Inc. for this purpose.
- All shafts have a maximum length of 10½" which can be cut to 1½".
- Specify heater type parallel and series 450 mA. or 600 mA.

## CUSTOMIZE

- Customized tuners are available at a cost of only \$15.95. With trade-in \$13.95. (U.S.A. only)
- Send in your original tuner for comparison purposes to any of the Centers listed below.

HEADQUARTERS	BLOOMINGTON, INDIANA 47401	537 South Walnut Street	Tel. 812-334-0411
ARIZONA	TUCSON, ARIZONA 85713	1528 S. 6th Ave.	Tel. 602-791-9243
CALIFORNIA	NORTH HOLLYWOOD, CALIF. 91601	10654 Magnolia Boulevard	Tel. 213-769-2720
	BURLINGAME, CALIF. 94010	1324 Marsten Road	Tel. 415-347-5728
	MODESTO, CALIF. 95351	123 Phoenix Avenue	Tel. 209-521-8051
CONNECTICUT	BRIDGEPORT, CONN. 06800	813 Madison Ave.	Tel. 203-385-0620
FLORIDA	TAMPA, FLORIDA 33606	1505 Cypress Street	Tel. 813-253-0924
	FT. LAUDERDALE, FLORIDA 33315	104 S.W. 23rd St., Bay 16	Tel. 305-524-0914
	MIAMI, FLORIDA 33150	7641 N.W. 7th Ave.	Tel. 305-754-1352
GEORGIA	ATLANTA, GA. 30310	646 Evans St. S.W.	Tel. 404-758-2232
ILLINOIS	CHAMPAIGN, ILLINOIS 61820	405 East University Street	Tel. 217-356-6400
	DALTON, ILL. 60419	1507-09 E. 142nd St.	Tel. 312-841-4444
	SKOKIE, ILLINOIS 60076	5110 West Brown Street	Tel. 312-675-0230
INDIANA	INDIANAPOLIS, INDIANA 46204	112 West St. Clair Street	Tel. 317-632-3493
IOWA	DES MOINES, IOWA 50319	5005 Douglas St. #5E	Tel. 319-278-4217
KENTUCKY	LOUISVILLE, KENTUCKY 40205	2244 Taylorsville Road	Tel. 502-452-1191
LOUISIANA	SHREVEPORT, LOUISIANA 71104	3025 Highland Avenue	Tel. 318-221-3027
MARYLAND	BALTIMORE, MARYLAND 21215	5505 Reisterstown Rd., Box 2624	Tel. 301-358-1186
MASSACHUSETTS	SPRINGFIELD, MASS. 01108	405 Dickinson St.	Tel. 413-788-8206
MISSOURI	ST. LOUIS, MISSOURI 63132	10530 Page Avenue	Tel. 314-429-0633
NEVADA	LAS VEGAS, NEVADA 89102	1412 Western Avenue No. 1	Tel. 702-384-4235
NEW JERSEY	TRENTON, NEW JERSEY 08638	1139 Pennsylvania Ave.	Tel. 609-393-0999
	PERSEPOLIS, NEW JERSEY 07307	547-49 Tonnetta Ave., Hwy. 1 & 9	Tel. 201-792-3730
	ROCHESTER, NEW YORK 14615	37 Pullman Ave.	Tel. 716-647-9180
NEW YORK	GREENSBORO, N.C. 27405	2914 E. Market Street	Tel. 919-273-6276
N. CAROLINA	CINCINNATI, OHIO 45216	7450 Vine Street	Tel. 513-821-5080
OHIO	CLEVELAND, OHIO 44109	4525 Pearl Road	Tel. 216-741-2314
	PORTLAND, OREGON 97210	1732 N.W. 25th Ave., P.O. Box 10141	Tel. 503-222-9059
OREGON	PITTSBURGH, PA. 15209	508 ½ Grant Avenue	Tel. 412-821-4004
PENNSYLVANIA	MEMPHIS, TENNESSEE 38111	3150 Barron Avenue	Tel. 901-458-2355
TENNESSEE	DALLAS, TEXAS 75218	11540 Garland Road	Tel. 214-327-8413
TEXAS	NORFOLK, VIRGINIA 23513	3295 Santos Street	Tel. 804-855-2518
VIRGINIA	ST. LAURENT, QUEBEC H4N-2L7	305 Decarie Boulevard	Tel. 514-748-8803
CANADA	CALGARY, ALBERTA T2H-0L1	448 42nd Avenue S.E. P.O. Box 5823, Stn. "A"	Tel. 403-243-0971

IF YOU WANT TO BRANCH OUT INTO THE TV TUNER REPAIR BUSINESS, WRITE TO THE BLOOMINGTON HEADQUARTERS ABOUT A FRANCHISE.

For More Details Circle (9) on Reply Card

**TSC**



WATCH US  
GROW



(Continued from page 4)

The IS CET (International Society of Certified Electronic Technicians) portion of the National Electronic Service Dealers Association (NESDA) new "time study" has revealed some unusual statistics. A survey of 81 shops gave these partial results:

- After what length of time do you consider a difficult repair job to be a "tough dog"? Average time was 2.7 hours, ranging between 1 hour and 12 hours;
- What was the greatest number of hours spent on any one "dog"? Average time was 8.4 hours (between 1 hour and 40 hours);
- In the past month, have you had an intermittent problem? Yes. 95%; and No. 5%; and
- What percentage of your repairs are intermittents? Average was 18%, ranging between 1% and 75%.

Television captions for the deaf is being considered by the FCC, according to the *Wall Street Journal*. The Public Broadcasting System has developed a system providing captions which would appear **only** on those receivers with a special decoding device. Also, the FCC is concerned with the visual presentation of emergency information, that now is audible only.

Zenith has developed a new type of color picture tube, which should offer improved picture quality while reducing picture tube costs. Corning Glass Works cooperated in the development of the glass envelope. Zenith plans to introduce some of these new tubes in a 19-inch size by late summer of 1976. More than 200 engineers and executives have seen the tube demonstrated early in March. Although Zenith has released no technical details of the new tube at this time, *Home Furnishings Daily* gave these industry rumors: a "sagging" process is used to contour lighter faceplates (rather than the present molding process); weight is less; the screen area is more rectangular than those at present; and processing of the phosphor dots is by a different, less expensive, method.

Japanese hi-fi manufacturers are planning innovations for the new season, according to *Home Furnishings Daily*. Sony might introduce a new 150-watts-per-channel amplifier using a digital "pulse-width modulation" circuit. Trio (Kenwood) plans an integrated amplifier with a separate power supply for each channel; this should reduce the cross-talk between channels and give better tone quality. For open-reel and cassette tape machines, several manufacturers are switching from the Dolby to the DBX system of noise reduction. Listeners with a preference for amplifiers with "tube sound" will be offered Sony and Yamaha equipment using "vertical-FET" output stages. The general trend is toward amps with higher power and better sound quality.

Retailers and manufacturers are expected to be familiar with the rules against selling non-type-accepted CB equipment. Also, it now is illegal to make, sell or use linear amplifiers.

The FCC is expected to expand the 27-MHz Class-D CB band to 50 channels, perhaps by this summer.

For the second consecutive year, Team Electronics has had a 300% increase in the sales of CB equipment.

---

# Panasonic

**A good product is made with the service industry in mind.**

**Panasonic went one step further...  
*We kept your customer in mind too!***



**It takes a lot of guts to build a Nationally Automated Parts Computer System that finds parts in seconds anywhere in the U.S.A..... especially when it doesn't get much use**

## **Panasonic did it!**

Check the yellow pages for the Authorized Panasonic Parts Distributor nearest you.

**PANASONIC  
NATIONALLY  
AUTOMATED  
PARTS  
FINDER  
SYSTEM**

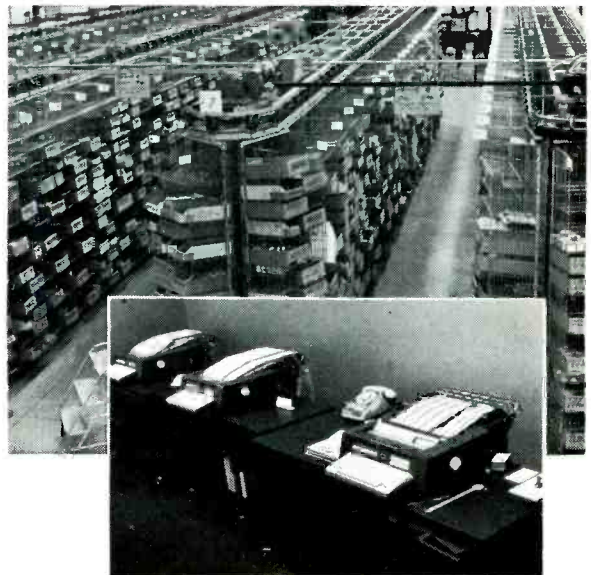

Panasonic Company  
Division of Matsushita Electric Corporation of America

**Panasonic**<sup>®</sup>  
just slightly ahead of our time

Panasonic Consumer Parts Division  
50 Meadowland Parkway, Secaucus, New Jersey 07094

**Chassis**—Zenith 19GC45 and 19GC48  
**PHOTOFACT**—None

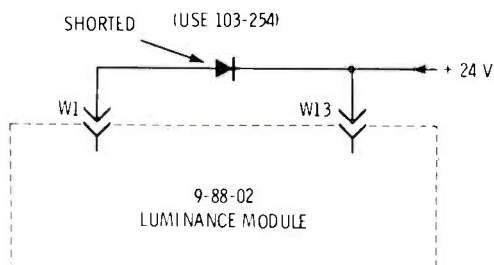

**Symptom**—Low brightness  
**Cure**—If not luminance module, check for shorted diode, as shown.

**Chassis**—Zenith 13GC10  
**PHOTOFACT**—1540-2

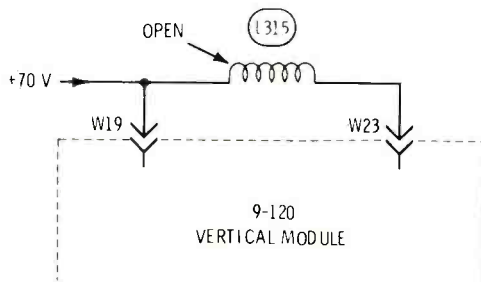

**Symptom**—No vertical height  
**Cure**—If not vertical module, check for open L315

**Chassis**—Zenith 17EC45 and 19EC45  
**PHOTOFACT**—1377-3

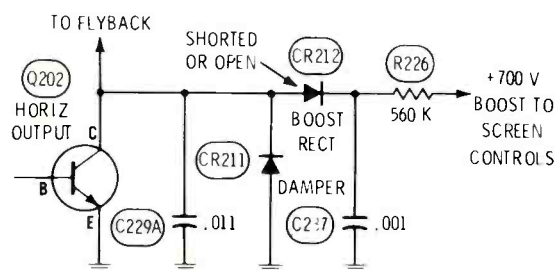

**Symptom**—Low brightness  
**Cure**—If there is no line with setup switch, check for defective CR212 boost diode.

**Chassis**—Zenith 17FC45 and 19FC45  
**PHOTOFACT**—1466-3

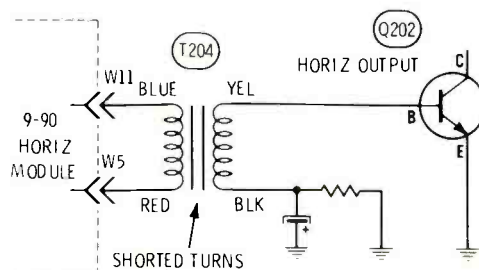

**Symptom**—Narrow picture with foldover  
**Cure**—Replace driver transformer, T204

**Chassis**—Zenith 17FC45 and 19FC45  
**PHOTOFACT**—1466-3

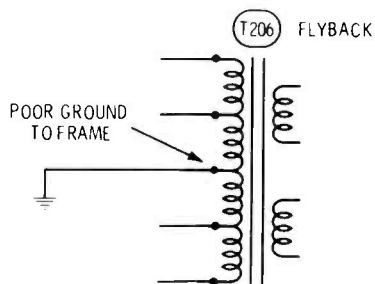

**Symptom**—Out-of-sync-color at edges; no color at center of screen.  
**Cure**—Check for poor ground at the frame of T206 flyback.

**Chassis**—Zenith 19GC45 with zoom  
**PHOTOFACT**—None

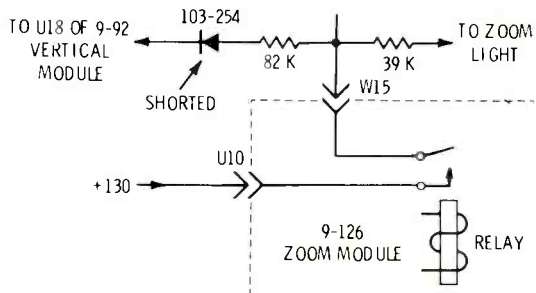

**Symptom**—Height excessive without zoom; normal with zoom  
**Cure**—Check for shorted diode, as shown.



## Weak vertical locking Wards Airline GHJ17429A (Photofact 1018-3)

At first this seemed to be a routine replacement of the 10GF7 vertical tube. Certainly, the circuit was familiar enough, because it was patterned after some RCA models.

But, the tube replacement didn't help. As the testing proceeded without any improvement of the locking, I began to feel some consternation.

Even a part-by-part check of all the components turned up nothing. RV1, the VDR that minimizes height variations, was not removed for a complete test because it was in a corner. It wasn't open or shorted, and I have never known one to fail, so I ignored it. After all, what would that have to do with the hold?

I'll condense a day-and-a-half of effort and just say the problem was caused by a short between the hot end of the VDR and the chassis pan. With the VDR hidden in a corner, it wasn't easy to see this short.

Of course, even those facts don't explain why the symptom was weak hold. **If the chassis pan had been circuit ground, the symptom would have been a complete loss of height.** But the chassis was isolated by two capacitors and a resistor, totalling .0122 and 470K in parallel, so the components were connected across the VDR by the short.

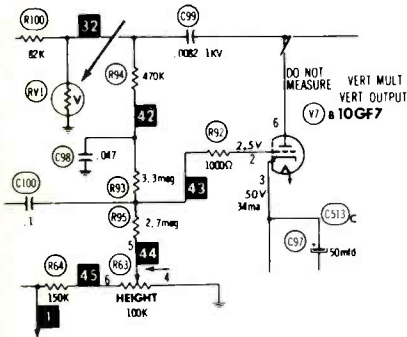

These values added to the circuit reduced the amplitude of the positive feedback (between the plate of the output and the grid of the oscillator section) and distorted the waveform. The result was a reduc-

tion of height. However, someone before me had restored the height by adjustment of the controls, thus wiping out the only clue.

Why did lack of height cause weak locking? Well, locking is determined by the amplitude of vertical sync relative to the oscillator-signal amplitude. Therefore, any large increase of oscillator output gives soft locking. You can prove this for yourself by increasing height and linearity, giving a picture that's too large for the screen of a non-defective receiver.

After some moving of components, the addition of a piece of fish paper, and re-adjustment of height and linearity controls, the locking was normal again.

Donald Kemner  
AAA TV Service  
Fortuna, California

## No raster Zenith 19DC12 (Photofact 1311-3)

Symptoms of no-raster without any rustle of high voltage led me to suspect components of the horizontal-sweep and HV circuits. The

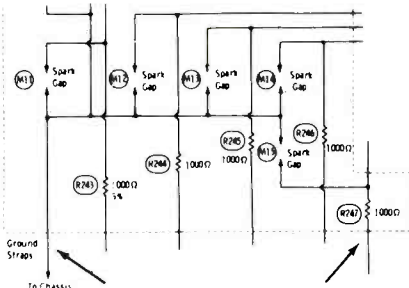

high-voltage divider resistor had melted plastic outside and was cracked. It was so obviously defective that I didn't bother to measure the resistance, but just replaced the resistor with a Zenith part number 800-616.

This restored the raster, but the picture had no focus. Only a trace of focus voltage was present at pin 9 of the picture tube. I removed both ground straps from the socket of the picture tube to the chassis and CRT frame, and measured some focus voltage between the strap and ground. Such a result indicates internal leakage of the picture-tube socket, which contains many spark gaps.

When I opened the socket for in-

spection, I found a charred path from pin 9 to the ground strap. Replacement of the socket and wiring with a 78-2031-02 brought in a good picture that could be correctly focussed.

Cliff Rigsbee  
Naples, Florida

## Excessive output current Sears Silvertone Chassis 529.62251 (Photofact 867-2)

The circuit breaker tripped occasionally, even after I replaced all of the horizontal tubes, and the power transformer seemed to be operating too warm.

Back at the bench, I opened the cathode circuit of the 6JE6A horizontal-output tube, and measured a current of 240 mills (about 40 mills too much). The efficiency coil adjustment produced a satisfactory dip of current, but couldn't reduce the current below 240.

Next, I scoped the waveforms at the grid of the output tube and on back to the horizontal oscillator. They were distorted. I started checking all components from the plate of the oscillator to the output grid, and finally found that C84 was shorted. This placed a 110K leakage (R130) at the plate of the oscillator tube, reducing the voltage, and changing the waveform so the drive at the output grid was too low. A new .0015 capacitor dropped the current to 200 mills.

Service tip: when the horizontal-output-tube current is excessive, or

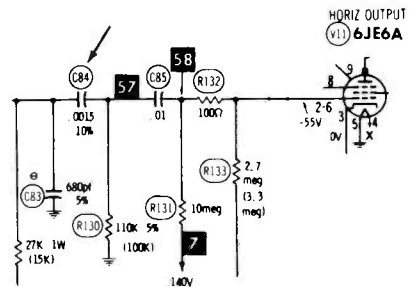

there is a slight loss of width or compression at the right edge of the raster, suspect a defect that is reducing the amplitude, or distorting the waveform, of the drive voltage at the output grid.

John T. Bailey  
Short Hills, New Jersey

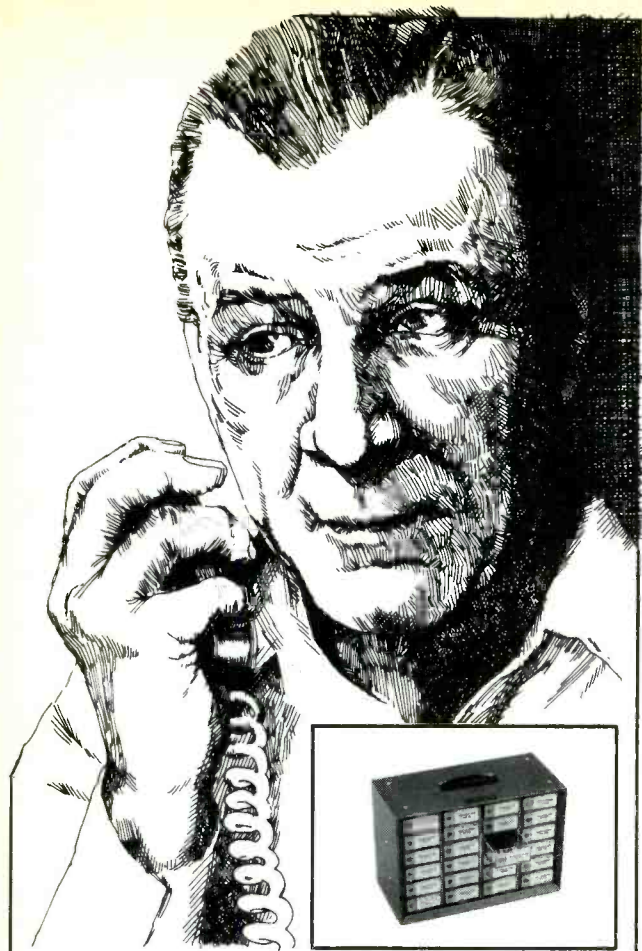

**KEEP THEM  
CONVOYS ROLLING!**

**GE replacement  
semiconductor kits to fix  
most popular CB rigs.**

GE kits—a great way to gear up for CB rig and scanner repair business. Parts you need most now! Really fast-growing segment of electronics. Over 7,000,000 CB rigs reported in use, with sales skyrocketing. Are you ready to fix 'em? See your authorized GE distributor for kits complete with special CB cross-reference guide (your key to picking the right replacement semiconductor for each popular brand rig.)

Tube Products Department  
General Electric Company  
Owensboro, Kentucky 42301

**GENERAL  ELECTRIC**

## reader's exchange

**Needed:** Schematic for Radiant portable cassette recorder, Model #440. Will buy, or copy and return.

Thomas C. Giaimo  
426 Central Boulevard  
Fort Lee, New Jersey 07024

**Needed:** Schematic and service information for a Model 772 Wilcox-Gay reel tape recorder. It has a counter, and is not exactly the same as the one in Photofact 406-12. Will buy, or copy and return.

James M. Thompson  
3724 Mainland Boulevard North  
Pinellas Park, Florida 33565

**For Sale:** Early issues of PF Index; best offer plus postage. Also, have antique radios to sell: Crosley Model 51 (not same as shown in Rider's Manual), and a Crosley Model 158 in good condition. Have many old tubes.

Arthur Draut  
900 Stanley Street  
Middletown, Ohio 45042

**Needed:** Service manual and schematic for Model 600 Electronics Measurement Corporation (EMC) scope. Will buy, or copy and return.

Jon Gyorfi  
91 Mary Lane, #304  
Glen Burnie, Maryland 21061

**Needed:** Schematic and service manual for a York Model 8TMPX-27C. Will pay \$5 for schematic, or \$10 for both schematic and service manual.

Massachusetts Specialty Co.  
444A Geneva Avenue  
Dorchester, Massachusetts 02122

**For Sale or Trade:** Complete color TV servicing course, with color TV and VTVM. Need 2-way radio course.

John G. Sepello  
6694 N. Manlius Road  
Kirkville, New York 13082

**Needed:** Audio-output transformer Z-3127A (7K primary/4 and 100 ohm secondary) for Lafayette RK675 stereo tape recorder.

Nick Senker  
65 Lehigh Avenue  
Piscataway, New Jersey 08854

**Needed:** Operating manual for Solar capacitor analyzer, Model #70552. Will pay \$5 plus expense for copying and postage, or send manual, will copy and return with the \$5.

Kenny TV Bench Service  
2801 Berry Street  
Sioux City, Iowa 51103



**Needed:** Carrier-level meter, part #82B100 for Halli-crafter communications receiver, Model SX-42. New or used: quote price.

A. C. Weiss  
11658 Harvard Drive  
Norwalk, California 90650

**Needed:** Instruction manual for McMurdo silver TV/FM sweep generator Model 911. Will buy, or copy and return.

Charles L. Rickard  
3228 Santiago St.  
San Francisco, California 94116

**Needed:** Parts for RCA Model 10T200 colorvoltage automatic voltage regulator. Want 74003 diode assembly, or 678 Tung-Sol thermal relay.

Roy Abo's TV Service  
Route 2, Box 107  
Paul, Idaho 83347

**Needed:** Cycle control lever, Glaser-Steers part number 13701-2, for Heath Model AD-60 record changer, or information about source for Glaser-Steers parts.

Fred Albrecht  
1303 Garrison Avenue  
Rockford, Illinois 61103

**Needed:** Schematic and information for a Freed-Eisemann, Model NR-7, #942EE. Also need OX-301A tubes.

Donald C. Treece  
Route 3  
Kahoka, Missouri 63445

**For Sale:** Telequipment D54 dual-trace oscilloscope, with set of probes. Triggered sweep, 10 MHz bandwidth, P31 CRT screen. One year old, and in mint condition.

Bob Goodman  
C/O Clark-Dunbar, Inc.  
P.O. Box 7416  
Alexandria, Louisiana 71301

**Needed:** Power transformer for RCA W065A scope, part #96788. Also need Rider's radio manuals, Volumes 1 through 7. Will buy, or trade antique tubes.

Troch's Television  
290 Main Street  
Spotswood, New Jersey 08884

**Needed:** Power transformers for Philco AM/FM radio, Model #47-1227. Philco part #32-8248, Stancor part #P4080, Merit part #P-3153, or Triad part #R-114A. Please write before sending a transformer, quoting price and condition.

Roy's Radio & TV Repair  
114 E. 3rd Street  
Burkburnett, Texas 76354

# WE'RE ON TRIAL

## But, you're the judge.

To introduce you to Dana's quality tested Danameter® 2000A we're offering you a **thirty day free trial** period to use our DVM and judge its new reliable features. If it doesn't fit your needs, return it...that's right, return it. Why make such a fantastic offer? Just look at what the Danameter 2000A offers!

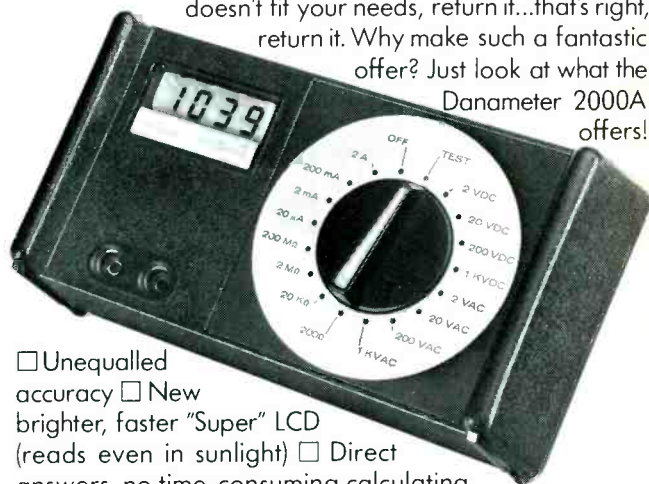

- Unequaled accuracy
  - New brighter, faster "Super" LCD (reads even in sunlight)
  - Direct answers, no time-consuming calculating
  - 1 full year battery life
  - LSI-CMOS circuitry
- And best of all...it costs only \$199.50!

Send for more details now...put us on trial. The new Danameter 2000A will come out ahead! For immediate action, call Cliff Hamilton at 714/833-1234.

**DANA**  
Others measure by us.

For More Details Circle (11) on Reply Card

## The Money Generator



**GENERATES  
MONEY FOR YOU!**

PAT.  
PEND.

**It's a DOG FIGHTER, TOO!**

The Model ATC-10 is much more than a color bar pattern generator. It should be called a **portable multi-purpose TV diagnostic and servicing aid**. But that's too much of a mouthful. We would have nicknamed it the **Dog Fighter** (instead of the Money Generator), but that might be misinterpreted to mean that it's only useful in the shop. The versatile ATC-10, a portable, moderately-priced instrument, combines the most essential features of a color bar pattern generator, a TV "analyzer," and a substitute tuner plus several brand new "dog fighting" and timesaving innovations. With all this extra versatility, however, the ATC-10 is human engineered with only four simple-to-master controls.

Two illustrated brochures describe the ATC-10. The first brochure describes the many unique and unusual features which make the ATC-10 a "dog fighter" and a time-saver. The second brochure illustrates the timesaving (money making) potential of the ATC-10 by comparing its capabilities with 18 competitive instruments. In all, 33 respective performance features are evaluated. We think the results of this evaluation will be a surprise to many. It clearly illustrates how costly it is for most TV service shops to purchase or continue to use less versatile equipment and shows how the ATC-10 has the potential of returning its \$299.95 purchase price in as little as 3 to 4 months.

These brochures are yours for the asking - write direct for immediate reply.

**American Technology Corporation**

225 Main, Dept. 4A, Canon City, CO 81212

For More Details Circle (12) on Reply Card

# Get in on the CB Service BOOM with the B&K Test Bench





# WITH THE MODEL 1040 CB SERVICEMASTER IT'S EASY, IT'S FAST AND IT'S PROFITABLE.

MODEL 1040  
\$250

The B&K-Precision CB Servicemaster is designed for rapid programmed testing and trouble shooting of any CB transceiver.

It functions as a test center and enables you to quickly check all of the significant performance characteristics of the transceiver with one hook-up—in a matter of minutes.

## When used with a scope and signal generator, you can:

- Measure signal-to-noise ratio of CB receiver
- Measure audio output power
- Measure audio distortion percentage
- Measure receiver sensitivity
- Check AGC
- Measure effectiveness of CB noise limiter or blanker (when used with an impulse noise generator)
- Measure squelch threshold
- Measure adjacent channel rejection
- Measure transmitter AM power output—even mobile!
- Measure SSB power output with TRUE peak-reading RF wattmeter
- Check AM modulation
- Check SSB modulation with a two-tone test—the only accurate way!
- Measure antenna SWR—even mobile!
- Check the transceiver in the car to determine if the problem is in the antenna system or the transceiver

You can save \$500—\$1,500 in equipment costs because the CB Servicemaster eliminates many of the test instruments you would otherwise need for CB servicing. These instruments, or their functions, are built into the unit:

- Audio wattmeter
- Audio generator
- Distortion meter
- RF Wattmeter/dummy load
- DB meter
- SWR bridge

These instruments—which you should have, if you don't own them already, are all you need to get the maximum use from your CB Servicemaster. And the B&K CB Servicemaster is compatible with most oscilloscopes, frequency counters, signal generators and power supplies on the market today.



### MODEL 1403A—3", 5 MHz Recurrent Sweep Oscilloscope

Checks CB modulation and provides viewing of 27MHz CB waveform when used with the Model 1040. Small, compact and inexpensive, it frees other scopes for more effective use.

Model 1403A \$198.



### MODEL 1640—Regulated Power Supply

Designed especially for CB and other mobile equipment, the 1640 eliminates changes in supply voltage due to load variations. A stable power supply is essential to precise testing of the transceivers. Less than 0.8% variation from zero to full load, 3 amps continuous, 5 amps surge. Adjustable to any output from 11 to 15 VDC. Suppressed zero scale for greater accuracy. Overload protected.

Model 1640 \$100



### MODEL 1801—Digital Frequency Counter

To quickly determine the exact frequency of a CB channel, the 1801 automatically displays it for you in large, easy-to-read digits. You can tune oscillators precisely (to 1Hz, if necessary), conduct audio frequency analysis tests. Six digit display is updated five times per second. Accuracy to 1Hz guaranteed to 40MHz; 60MHz typical.

Model 1801 \$240.



### MODEL 2040—CB Signal Generator

Covers all 23 channels, AM and SSB with built-in capability of 64 additional channels for future FCC assignments. Ultra-stable crystal-controlled, phase-locked-loop frequency generation. Has 10 ppm accuracy. 1  $\mu$ V to 100 MV output in calibrated 10 dB increments for receiver sensitivity measurements. Includes EIA standard noise test signal generator to check receiver noise suppression. Internal 400, 1000 and 2500 Hz modulating frequencies—can also be externally modulated. Internal protection against 5W RF input.

Model 2040 \$475

For additional information, contact your B&K-Precision distributor for our comprehensive brochure describing the operation of the Model 1040 CB Servicemaster and the CB Service Center—or write us for your free copy.

## **B&K** PRECISION

**DYNASCAN CORPORATION**  
Makers of Cobra CB Equipment

1801 W. Belle Plaine Ave.  
Chicago, IL 60613 • (312) 525-3990  
in Canada: Atlas Electronics, Toronto

# GETTING THE SNOW OUT OF UHF

By James E. Kluge, Technical Editor, Winegard Company

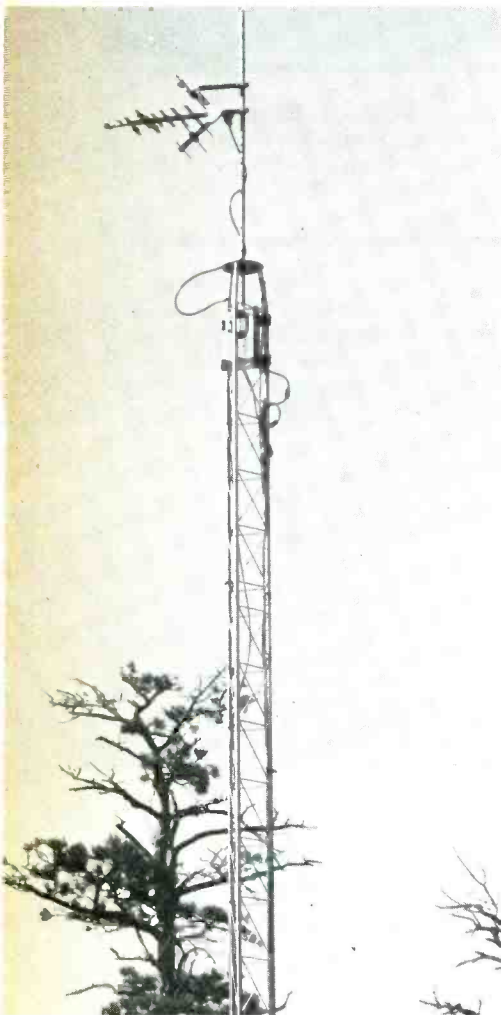

A new-type Winegard UHF antenna looks across the Rocky Mountains near the Winegard Research Laboratory.

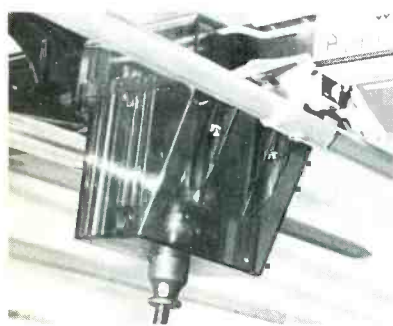

Be sure the pre-amplifier has weatherproof protection, and mounts directly to the boom.

*Judged for sharpness and rich colors, the quality of pictures from UHF stations should far exceed that of VHF. Unfortunately, these desirable results can't be obtained without planning and effort. All antenna equipment and installation methods must be correct, as described in this article.*

Color-television pictures of the sharpest and best quality **can** be (and **should** be) received from UHF stations. Although many UHF programs have snow, smear, ghosts, and intermittent color, it should not be that way. Much depends on the antenna system, including the installation.

## More UHF Losses

UHF signal losses are greater than those of VHF, at all stages from antenna to receiver. This fact-of-life sometimes causes problems with snow from insufficient signal.

### Cable and air losses

Chart 1 shows the loss in RG-59/U foam dielectric coaxial cable (often used in MATV and CATV systems) to be 2.1 dB per 100 feet for Channel 2, and 8 dB at Channel 83, the top of the UHF band.

In addition, UHF signals coming through the air have a loss of -6 dB (half voltage) each time the frequency is doubled.

### UHF antennas are smaller

One basic limitation of the gain from UHF antennas is that they are smaller than VHF antennas. Shorter-length elements are required to tune the higher frequencies. Unfortunately, shorter elements give less signal output, although the reason is not readily apparent.

This important characteristic determining the gain of any antenna is called "antenna capture area". Or, to state it another way: more antenna area is required to intercept more signal waves, thus producing a stronger signal.

### Line-of-sight

Another factor reducing the

fringe signal strength is that UHF signals come close to following a true line-of-sight path. The higher frequency of UHF signals doesn't permit much bending of the beam, so locations below the horizon usually receive weaker signals.

Also, antennas behind a hill or building pick up less signal strength than a VHF antenna would with a VHF signal. Even leaves on trees or water vapor over lakes can absorb an appreciable amount of transmitted UHF energy before it reaches the antenna.

### Total losses

To summarize the losses, UHF signals are weaker than VHF signals under equivalent conditions because of:

- less UHF signal from the antenna;
- more losses from higher frequency and transmission line; and
- more attenuation between transmitting and receiving antennas.

If UHF signal strength is to **equal** that of VHF, it's clear that effective measures must be taken. VHF routine methods are not enough.

## Improving UHF Performance

Assuming that the location calls for all the signal strength you can get, **you should select the biggest antenna available, and raise it as high as possible.**

### Antenna height

Although theory indicates even greater heights are desirable, a 30-foot tower is a reasonable compromise in size and weight. If it's properly guyed, such a tower can support the largest antennas, even



## Chart 1 Cable Attenuation

Type Of Cable	Loss Per 100' In DB'S				
	Ch 2	Ch 13	Ch 14	Ch 48	Ch 83
RG-59/U	2.6	5.4	8.4	10.5	12.0
RG-59/U Foam	2.1	4.1	5.8	7.1	8.0
CL-2700	2.2	4.4	6.5	8.0	9.1
CL-2800	1.6	3.2	4.9	6.0	6.8
RG-11/U	1.4	3.2	4.8	5.8	6.8
RG-11/U Foam	1.1	2.3	3.5	4.3	5.1

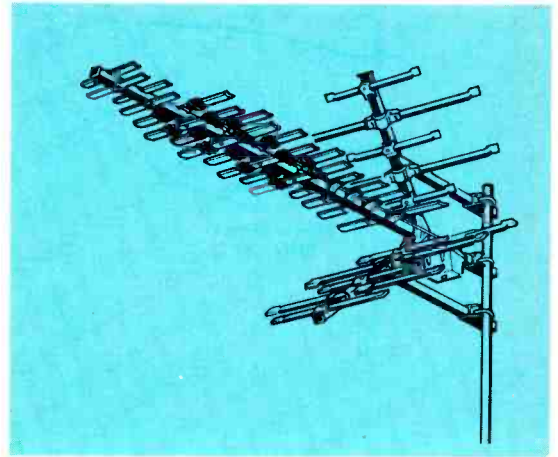

Fig. 1 This is Model CH-9095, the most powerful of the Winegard UHF-only antennas.

ones that are stacked to increase the gain, or to supply better directivity.

**A few words of caution:** Before you make a final decision about the location of the tower, use a portable antenna on a high mast to probe for the location giving the best signal quality. At UHF frequencies, even a few feet up/down or left/right often can make a huge difference.

### Mast-mounted preamplifiers

Next in importance to a large antenna with a high elevation is a UHF preamplifier at the antenna. The signal at the antenna is the best possible, considering the location, antenna, and height. The signal-to-noise ratio can only deteriorate from that point, so it's best to amplify the signal where it has the least amount of snow and ghosts.

Look at it this way: each TV antenna has a relatively-constant minimum voltage level of thermal noise (snow), which varies only slightly with temperature.

The signal level versus the -59 dBmV of antenna noise determines the signal-to-noise ratio at the antenna terminals. When the signal is attenuated by downlead, or other parts of the system, the antenna and receiver noises stay the same. Therefore, as losses reduce the signal, the signal-to-noise (S/N) ratio is degraded. Amplifiers can't

improve the S/N ratio, but they can keep it almost as good as it is at the antenna.

Of course, every amplifier adds some noise of its own which reduces the S/N ratio. The solution is to use a preamplifier with the lowest noise figure (N.F.). A UHF preamp with a voltage gain of 15 dB or more and a UHF noise figure of 10 dB or less is considered good; while under 6 dB N.F. is excellent.

Although most Winegard UHF preamps have a noise figure of 8.5 dB, Winegard has developed one that has a noise figure of 2 dB or 3 dB, depending on the channel. **This 6-dB improvement is equivalent to a perfect quad stack** (4 antennas stacked). Therefore, a low-noise preamp can be the best answer for offsetting the losses in the cable from the antenna to the receiver.

One more thing, be sure the preamp is protected by a weatherproof housing.

### A large antenna

If the location is in the fringe area, it's obvious why a big antenna should be used. Even if there's plenty of signal, a large antenna might be desirable for ghost rejection. Or the extra signal level could help overpower some local noise.

Stacking antennas has much to recommend it. Not only does stacking provide more signal to bring up the signal out of the snow, but it also gives a sharper directivity pat-

tern, minimizing ghosts.

In extreme cases, an experienced antenna installer can adjust the stacking configuration and the kind of antenna (such as directional, high-gain yagis) to "tune out" unwanted signals while doubling the level of the desired signal.

### New antenna designs

UHF stations no longer are the "poor relatives" of TV broadcasting, and the antenna companies have devoted much research for the development of better UHF antennas.

For example, Winegard has two basic changes called "Planar Grid"™ and "Tri-Linear"™ directors (see the drawing of Figure 1).

One previous way of increasing the UHF-antenna gain was to add directors, which were tuned either to the high end or to the low end of the band. In fact, some were designed for highest gain at the low UHF frequencies, then if the installer wanted more gain for higher channels, he could shorten the directors by breaking off the tips at notches provided for that purpose.

A combination of Planar Grid and Tri-Linear directors flattens the response so it's not necessary to shorten the directors. Planar Grid is the driven array, which is rear-fed and has multi-elements. In front are the Tri-Linear directors. Each director is made in three parts, that are attached end-to-end

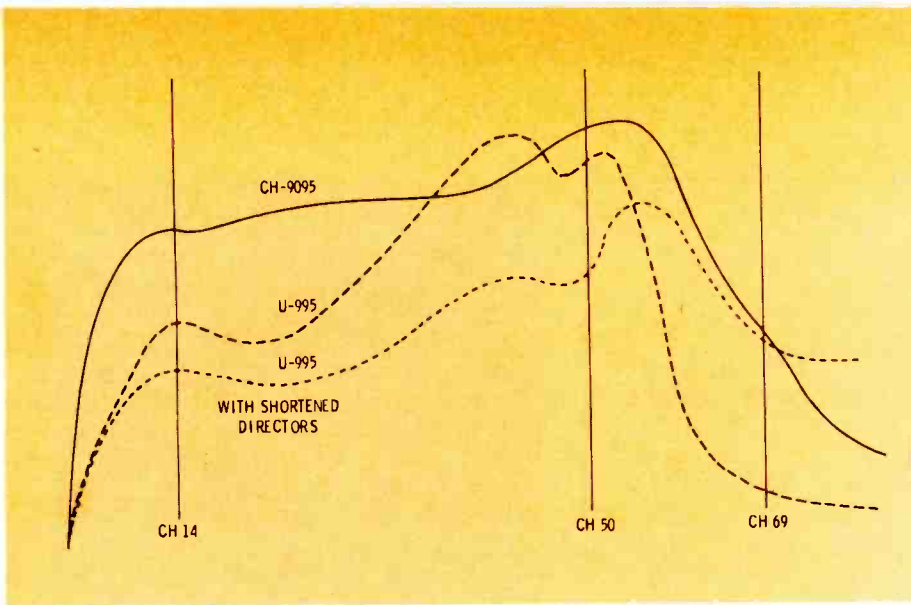

Fig. 2 The solid-line curve shows the approximate frequency response of the Model CH-9095, the curve of dashes is the "normal" response of the U-995 (which is superceded by the CH-9095), and the dotted curve shows the improved high-frequency response and reduced low frequencies when the directors of the U-995 were shortened.

by insulators. Each resonates as an individual director at high frequencies, but all three together (three times the length) tune the lower channels.

These antennas have approximately 15 dB of gain, which is equivalent to extending the fringe area by another 20 or 30 miles (Figure 2).

#### Choice of downleads

On the basis of the attenuation losses for the various kinds of twin-lead and cable, and without any other consideration, it would seem that 300-ohm twin-lead would be the best choice. However, there are many other reasons why twin-lead is a poor choice.

Careless routing and positioning of twin-lead sometimes can eliminate a UHF channel, which otherwise would be useable. Primarily, this is because the quarter wavelengths at UHF frequencies fall between 3 inches and 6 inches. Therefore, the nearness of the lead wire to metal objects can create severe problems. Even worse, any coiling of excess twin-lead is certain to degrade the picture quality.

Twin-lead, when it's clean and dry, works very well. But when the air is damp or the lead becomes dirty, the picture quality is degraded. Also, unshielded twin-lead is susceptible to man-made electrical noises. What's more, twin-lead can act as an antenna element,

picking up signal which often appears as **leading** ghosts.

#### Coaxial cable

Coaxial cable does have higher losses than twin-lead does, but it has many advantages. If the signal level is strong, any moderate attenuation won't be noticeable; the receiver AGC will compensate.

Installation for good-quality pictures is much easier with coaxial cable. It is not sensitive to any metal nearby (run it through conduit, if you like). Really, the only serious precautions are that you do not bend the cable too sharply or dent it with staples.

Usually, it's easier (and often less expensive in the final analysis) to use coax and add a preamp or amplifier to restore any UHF signal lost in the cable (see Figure 3).

#### Don't use bargain cable

Don't buy seconds or unbranded coaxial cable. Look for the manufacturer's name on the cable. Even at VHF frequencies, cable with slight defects can affect the picture quality adversely. The problems are much worse with UHF.

For example, make sure the cable is **actually** 75-ohms impedance at UHF frequencies. You can't test it, so buy name-brand cable only.

Incidentally, if you staple down the cable, do it with random spacing between staples. Equal-spaced staples that dent the cable surely

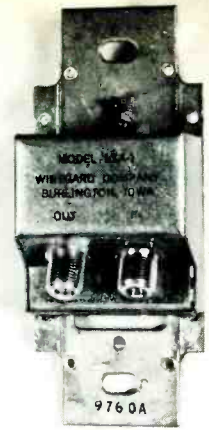

Fig. 3 Model LTA-1 is a wall tap outlet, for MATV and CATV, that has a UHF amplifier built-in to compensate for the higher cable losses at those frequencies.

will "suck out" some picture channel.

#### Match impedances

Matching of the impedances is not a very large problem in simple systems. Just be sure to match the impedance of the antenna to the impedance of the transmission line; and match again at the other end between the twin-lead or cable and the TV terminals. Many late-model receivers accept 75-ohm coax; wire it that way, if possible. This reduces the amount of unshielded lead wire; and the tuners usually are 75-ohm impedance internally, which eliminates a couple of matching coils.

#### Comments

Smooth, wide bandwidth with minimum phase distortion is easier to obtain with UHF frequencies (compared to VHF) in both transmitters and receivers. In addition, few kinds of man-made electrical noises extend to such high frequencies.

UHF seems ideal, but the only catch is that better components and workmanship must be used in the receiving antenna system to reach the potential.

Observe the suggestions about coaxial cable and its proper installation, and use the new types of antennas and preamps to bring in sharp, stable color pictures without fading or variable ghosting. □



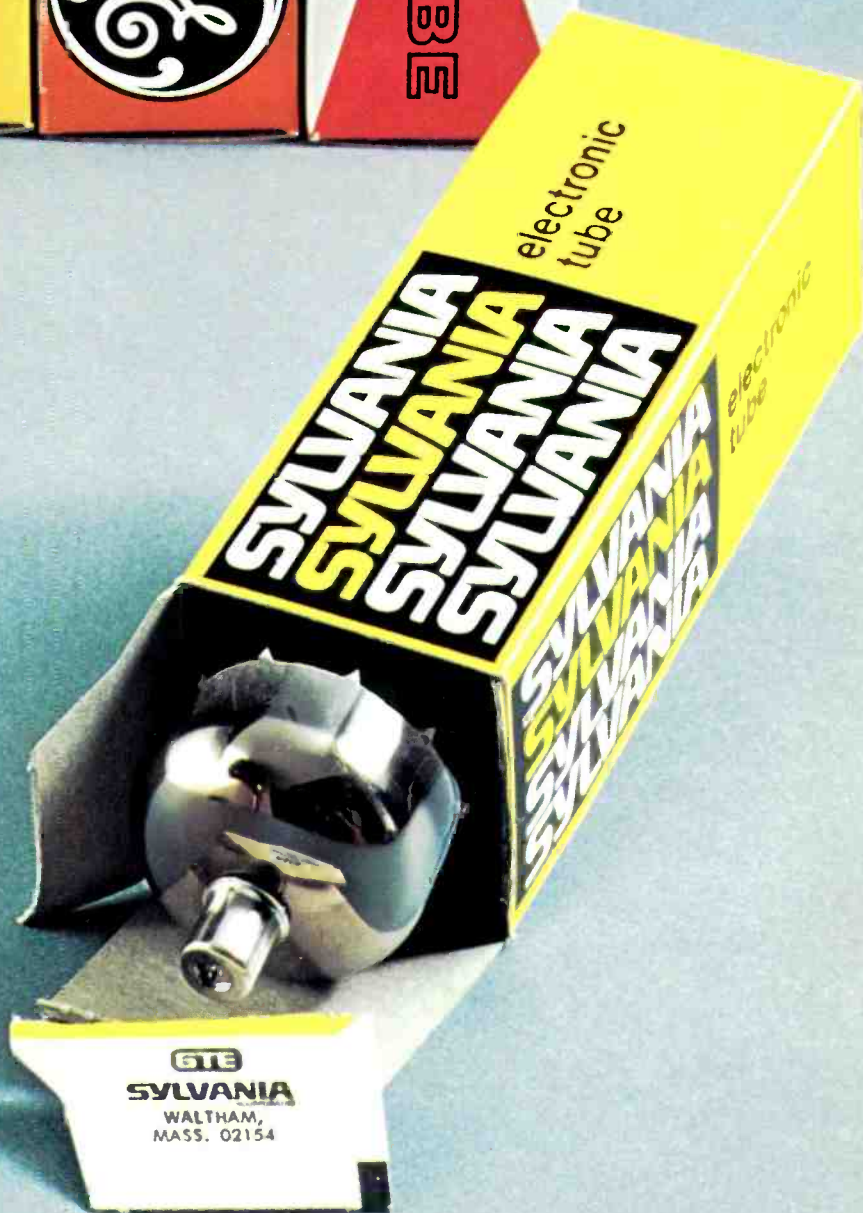

TABulate  
the  
difference...

Today, the difference is awards. Hundreds of them. They're yours when you save the tabs marked "Waltham" found on every receiving tube box.

There's never been a better time to "rally 'round the tab!" Start collecting them now through November 30, 1976. And you don't need a million of 'em to earn a prize.

Visit your local authorized Sylvania Distributor and pick up your free Sylvania "rally 'round the tab!" Award Catalog, special Tab Saver Envelope, and Award Order Form with complete instructions. Or fill in the handy order form below.

It's a great way to save all around. Save time by stocking the broadest line of tubes—Sylvania. Save on great merchandise with Sylvania tabs.

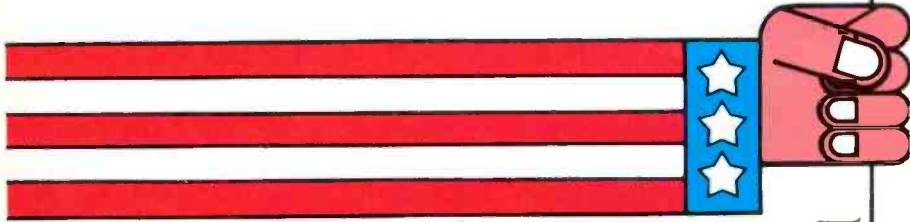
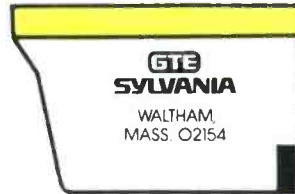

# rally 'round the tab!



**GTE SYLVANIA**

*rally 'round the tab!*

MAIL THIS CARD TO:  
**SYLVANIA AWARD HEADQUARTERS**  
 P.O. Box 1000, Fenton, Missouri 63026

NAME \_\_\_\_\_

COMPANY \_\_\_\_\_

ADDRESS \_\_\_\_\_

CITY \_\_\_\_\_

STATE \_\_\_\_\_ ZIP \_\_\_\_\_



The Sylvania "rally 'round the tab!" program is available only to dealers and service technicians.

Employees of General Telephone & Electronics, GTE Sylvania, their subsidiaries, affiliates, authorized franchised distributors, or their advertising agencies are not eligible to participate.





# PARTS SALES... Profit Or Loss?

By Carl Babcoke

*Many service dealers have reported reduced profits (or even losses) from their parts-department sales. The following discussion explains how this can happen to a modern service business, and some remedies to apply.*

We're all aware that tremendous changes have taken place these past few years in the business of servicing electronic products used for entertainment in homes.

Probably most of you have examined your own labor expenses and pricing formulas, before raising the labor prices enough to realize a modest profit. But what of your profit and loss from parts sales? Have you investigated that financial aspect as thoroughly as you did labor pricing? Some service dealers are finding, to their disgust, that the parts department is losing money. In these difficult times, none of us can afford to take a loss in **any** department.

Truth is, the traditional discounts no longer are adequate. Let's take a look at the past, comparing the conditions then with the ones of today.

## Traditional Radio-Parts Markup

In the years before TV, few problems existed with parts inventory, or with the pricing of those parts. Most price sheets showed "list" figures only, and the standard discount to the servicer was 40% of list. For example, a component listing for \$1.00 cost the dealer 60 cents.

Stocking parts for radios was simple. An adequate, typical inventory included:

- several dozen fast-moving types of tubes;

- an assortment of mica and paper capacitors;

- several universal sizes of electrolytic capacitors;

- a drawer of standard-value resistors;

- a few small speakers with output transformers;

- several universal audio volume controls with switch; and

- a few coils, such as 455 KHz (kilocycle, we said then) IF transformers, antenna coils, oscillator coils.

These parts and tubes operated just as well in Majestic and Fada radios as they did in RCA and Zenith. With point-to-point wiring, most small parts fit with no problems. Of course, we often modified the parts or made equivalent substitutions, such as a tubular, card-board-cased filter for an aluminum-can type. Turnover was high, and the components seldom became obsolete.

Small components, such as resistor and capacitors, usually were billed at \$1 to \$2 each, but larger components were sold strictly according to the list price.

## TV Parts Problems Were Obscured

The popularity of TV receivers started some serious problems in stocking and pricing parts, although the difficulties were not recognized at first. Tubes, resistors,

and capacitors remained universal over a wide range of brands and models. But flybacks, yokes, and most transformers required exact replacements. How many "turns" are possible with a reactance coil or a flyback that was used in just one model?

However, the one factor that masked the twin problems of slow-moving components and obsolescence, while it kept profits healthy, was the sale of tubes. The failure rate of tubes was high, and the discounts had risen to between 50% and 70%, while other components continued with the traditional 40%.

Thus, **the unusually-high markup from tubes kept the overall parts sales profitable.** (Even today, many shops probably owe their solvency to profits from tube sales, although that source of revenue is drying up rapidly.)

## The Negative Side Of Solid State

Modern stereo and TV machines without tubes have brought a profit crisis to the parts department of many service dealers. Solid-state devices **do not** fail as often as the tubes they have replaced, and much of the universality is gone. Yes, I know about and appreciate the universal transistors. But, how many RCA modules will operate in a Quasar? Can you expect a Zenith module to work right in a Magnavox?

To state the situation plainly, tubes (which would work in many different brands and models, and were very profitable to sell) have been eliminated in favor of plug-in modules (which only fit **one** brand each, and carry only the "standard" discount. Probably this is the largest factor in the loss of profitability.

But, there's more. Many of the components in late-model TV's are special safety types (such as fire-retardant resistors). Unless you use replacement parts of the same rating, you might legally be held responsible for any damage or injury resulting from your failure.

This change from universal parts to specialized ones, mainly because of solid-state components, generally has decreased the volume of parts sales, and increased the total inventory. With the high interest rates

and inventory taxes, it's possible for a shop to lose money on the parts-department operation.

### A Solution?

John Sperry, originator of the Sperry Tech system of pricing labor and parts, is one dealer who believes the 30% to 40% gross margin on parts is not sufficient to cover present-day costs.

If this view is correct, it follows that you should "build in" some charges to cover the parts losses. Should you increase the labor rates? Probably not, if you have based them on actual costs. Customers still resent paying for labor more than for parts. What about adding a "handling" charge to all jobs? Well, that might work, but it would not be very fair, because some customers would have to pay more in proportion than others would.

Instead, John suggests that each service dealer make up his own "list" prices, based on the total parts net cost (for a certain period) versus the total parts expense. From these figures, each owner or manager would determine what markup is needed to obtain the net profit he wants from the sales of parts.

### Parts expenses

Here is a reminder list of some expenses that should be included:

- interest on money borrowed to buy parts (or interest you should have for tying up your cash);
- a fair "rental charge" for the space occupied by the parts stock. Also, add pro-rated charges for lighting, heating, air-conditioning, and janitorial services;
- salaries for part men and phone-order personnel, according to actual times spent on parts business;
- salary for owner or supervisor (pro-rated);
- direct shipping expenses, including truck costs for local pickups;
- losses from breakages or shortages;
- costs of obsolete parts that are discarded;
- inventory labor and record keeping (if not included before); and
- inventory taxes.

This list probably is not com-

plete. Add other expenses as they occur to you.

### Computing list prices

Adding your net cost of parts to the total parts expenses for the time of computation gives the selling price without any provision for net profit. If you have included all expenses correctly, a small percentage additional for actual profit is fair and normal. Many electronic wholesale distributors operate for about 1% net profit. Some grocery chain stores are happy to show a 5% true net profit. But you can bet they have been very careful to include all legitimate expenses before that point.

Total parts cost plus total parts expenses plus your profit equals the correct total selling price for you. These figures are easiest to handle if they are expressed as percentages.

Let's assume, as a hypothetical example, that the net parts cost was 42%, expenses were 53%, and profit was 5%, making a total of 100%. After this has been established, the expenses are added to the profit, leaving only net parts cost and expenses (or overhead).

The simplified formula now is: net cost (42%) plus expenses (58%) equals list price (100%). From the formula, you can calculate all your own list prices.

### Watch the mathematics!

Arriving at list prices from net prices is completely different from obtaining net prices (or gross profit) from list prices.

In the days of the standard 40% discount, you merely multiplied the list price by 60% to get the net cost, or by 40% to obtain the gross profit of each component.

On the other hand, the net cost would require multiplication by 1.66 (166%) to reach the list price, using the old discount structure.

Going back to the previous figures (net 42% and expenses 58%), multiplying the net cost of each part by 2.38 (238%) gives the "list" price you wanted. The 2.38 was obtained by dividing 42 into 100.

Of course, you must arrive at your expenses from your actual figures, and only you can decide what profit you want.

Just remember, it is considered illegal "price fixing" if you merely

use the markup or percentage of profit calculated by another business.

### Inexpensive parts

Modern cost-accounting methods have proved that the expense of stocking each low-cost component is nearly the same as stocking another part that sells for a much-higher price. Your parts pricing system should take this into account.

This can be done by any of several ways. One is to establish a minimum price per part. Another adds a "stocking" charge to each component. All of these methods have the effect of providing a higher markup of those low-priced items which have caused losses before.

### Is Such Pricing Legal And Moral?

Even shop owners or managers (who know more income is needed from their parts departments) often are reluctant to sell parts above the manufacturer's list. Yet it is both legal and moral to do just that. Legally, **you can sell merchandise for any price**, providing you and the customer agree on the price, and the transaction is made in a competitive market. This general concept is behind the Federal laws prohibiting price-fixing, and the new law eliminating Fair Trade prices.

And, certainly it is moral to operate your business efficiently so you can avoid losing money.

### Theory And Practice

I have presented these suggestions as though they were theories that have not been tested. But many businesses already are operating as described. In fact, John Sperry (Sperry Tech, Incorporated) has a plan for providing "Computerized Parts-Pricing Service." A service dealer furnishes a mark-up multiplier and a stocking-charge (if desired), and for a nominal fee Sperry Tech has a computer print-out made of more than 3500 fast-moving parts. Then the print-out is reduced in size and bound in a shirt-pocket-sized book called "Parts Satellite". If you have any questions, write to: Sperry Tech, Inc., P.O. Box 5234, Lincoln, Nebraska 68505. □





"I know it's a tough dog because it bit me!"

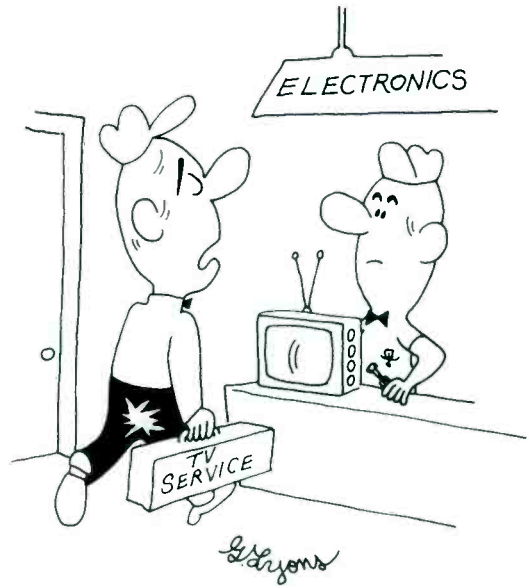
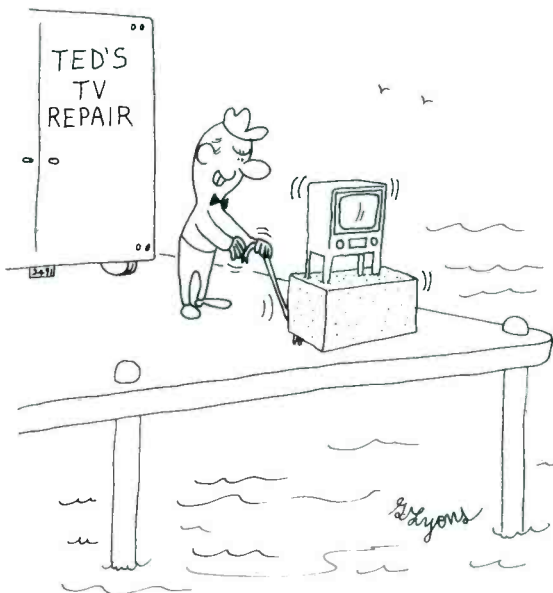

"My last service call involved a tough dog!"



"We haven't had a call for a part like that in forty years...How are you fixed for speakers?"



"Talk about violence on TV—you should have heard the repairman trying to fix our old set!"

# SERVICING RCA XL-100

Part 6/By Gill Grieshaber, CET



*Flyback, high-voltage, and brightness-limiter circuits are explained, continuing the theory of the CTC58 basic horizontal sweep, which was given in the February issue. Also, we suggest some practical troubleshooting tests, that should help you pinpoint most sweep defects.*

Horizontal sweep in the RCA SCR circuit operates efficiently without a flyback or any high-voltage circuitry. However, strong horizontal pulses are created during the retrace time, and they are used for various purposes, including the production of high voltage for the picture tube.

## Flyback Furnishes Pulses

Terminals 11 and 12 of T403 (Figure 1) connect to the trace switches, CR401 and SCR101, and C410 is an AC ground to either terminal 7 (for normal width) or terminal 8 (to give more width). That's how pulses from the trace circuit reach the flyback.

## B-boost supply voltage

Positive-going pulses of about 1200 volts PP at terminal 15 are rectified by diode CR104, and the DC voltage is filtered by peak-reading capacitors C107 and C108, producing almost +900 volts for the controls that adjust the screen-grid voltages for the picture tube. This is the B-boost supply.

Loss of the B-boost eliminates the raster, even though the high voltage still is functioning. Lugs with all three screen-grid voltages are easily accessible on board PW600, the one the MAB003A power-supply module plugs into. If the screen voltages are around +240, check for shorts or opens in

CR104, or for shorts in C107 and C108.

## Other pulses

Positive-going pulses from terminal 3 go to the video, AGC, and the burst keyer; so a complete open in that winding could cause video defects, loss of locking, and loss of color.

From terminal 5, positive-going pulses are sent to the HV control, and to the excessive-HV protective circuit. Loss of these pulses could produce excessive high voltage without the protective circuit operating to throw the horizontal out-of-lock.

Negative-going pulses from terminal 6 are used for: blanking in the video; keying the AGC; rectification which provides negative voltage for the CRT bias; and horizontal convergence. Without the pulses, the loss of AGC would be the symptom most noticed.

Incidentally, when terminal 3 or 5 was shorted to ground as a test, the picture narrowed to about half width. But a grounded terminal 6 eliminated the raster. Probably the breaker would have flipped within a few seconds, if my courage had permitted a longer overload time.

## High Voltage

Of course, the most important pulses are the ones that supply the high-voltage tripler, a sealed assembly (with diodes, peak-reading

capacitors and resistors) that produces high-voltage for the picture tube.

## Focus voltage

Focus voltage also comes from the tripler assembly by way of terminal "F", which is connected internally to the rectifiers. As shown in Figure 1, R117, R116, R118, and R119 supply a focus voltage that's variable from about 3.5 KV to 5.5 KV.

This one receiver focused best with 4.8 KV, when the high voltage was 24.5 KV. (Most picture tubes of this kind require about 20% of the high voltage.)

## Brightness limiter operation

Terminal "DC" of the tripler is the low side of the rectifier circuits, so a **negative** voltage is produced by picture-tube anode current. Increased CRT current causes an increased negative voltage at "DC", and the negative voltage is used by the brightness-limiter circuit.

Here is how it works: Q302, the brightness-limiter transistor normally is forward biased very strongly (about +0.76 volts), causing the collector to be virtually grounded. The zero collector voltage reduces the DC voltage at the end of the brightness control, and the voltage from the center lug goes to terminal 10 of MAL001B module to determine the brightness. A less-positive voltage increases the brightness,



Imperial Electronics installers  
Dean Johnson and Pete Childers say:

# "We advertise Winegard antennas exclusively."

Installers in  
Every Part Of the U.S. Praise  
Chromstar Performance, Construction.

Imperial Electronics of Joliet, Ill. is no exception. They state "We sell and install Winegard antennas because we consider Winegard to be the best manufacturer, making the strongest and best performing TV antennas, the Chromstar Line.

We serve an area 40 miles and more from Chicago, which gives us a lot of different signal strength problems, especially UHF. The complete Chromstar line gives us antenna models to do the job and solve the reception problems.

Because the Winegard name is so well known, and we have full confidence in their products, we feature them in our newspaper and radio advertising. This boosts our sales, and keeps us busy putting up Winegard antennas in our area."\*

\*Upon request, a copy of the letter from Mr. Johnson and Mr. Childers will be sent to you.

Get complete product  
information and spec charts  
from your Winegard Distributor.

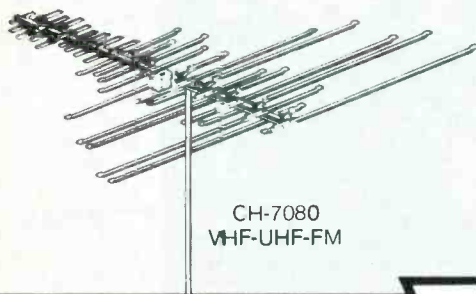

CH-7080  
VHF-UHF-FM

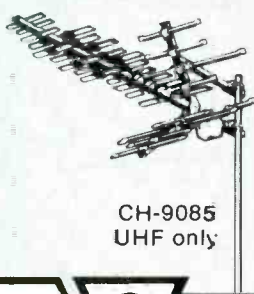

CH-9085  
UHF only

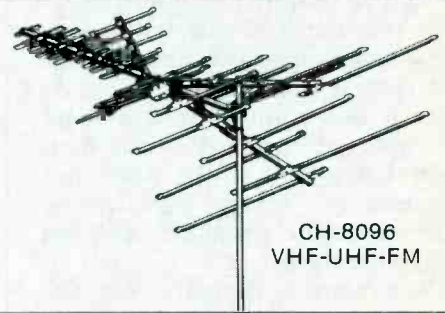

CH-8096  
VHF-UHF-FM

TV ANTENNAS  
MORE PEOPLE LOOK UP TO.



**WINEGARD**<sup>®</sup>  
C O M P A N Y  
3000 Kirkwood • Burlington, Iowa 52601

For More Details Circle (4) on Reply Card

and a more-positive voltage darkens the picture.

If the brightness control (R4202) is turned for excessive brightness, the DC voltage at terminal "DC" becomes as much as -4 volts, and it goes through R122 and R320 to decrease the forward bias of Q302. With less bias at the base, the collector becomes more positive, thus making the brightness control more positive and decreasing the brightness.

Of course, excessive brightness because of a defect in the video stages following the brightness control is corrected in the same way. In other words, **the brightness-limiter circuit does nothing until current through the tripler is above the point specified by the design. At such times, it operates to reduce the picture-tube current.**

For a test of the operation, I adjusted the brightness control for a very bright picture (so the circuit would reduce the brightness), and recorded the DC voltages at the three terminals of the brightness control. Then I unplugged the base socket of the picture tube (which reduced the CRT current to zero, without changing the setting of the control), and again wrote down the voltages. These were the voltages:

	"low"		"high"
	lug	center	lug
bright ...	+9.35	+6.1	+5.85
no raster .	+8.50	+4.8	+4.45

In addition, the collector of Q302 changed from +2.9 volts with high brightness to +.03 with no raster. Such voltages verify the limiting action.

Another proof is to measure the DC voltage at the center lug of the brightness control when the control is turned completely counterclockwise (about +8.5), and notice that the voltage decreases smoothly as the control is turned clockwise. At least it does until it reaches about +6 volts; additional clockwise rotation from that point does not decrease the voltage significantly. **The automatic circuit is opposing your adjustment.**

You should measure the DC voltage at terminal 10 of module MAL001B, anytime there's a problem of incorrect brightness. Another test is to connect a bias supply to this point and vary it

around +6 volts, noticing if normal brightness can be obtained.

If diode CR103 shorts, the brightness-limiter circuit cannot operate.

### Troubleshooting SCR Sweep and High Voltage

Some conventional methods of testing horizontal circuits can be used with the SCR sweep circuits of the RCA CTC58 chassis. But there are important differences, as listed here:

- Loss of **all** oscillator signal at the gate of SCR102 allows the trace and retrace circuits to idle, without sweep or HV, and without any overload (the circuit breaker does not trip);
- A solid, permanent short across SCR101 or CR401 also does not overload either the trace or retrace circuits, and the retrace side has both an AC waveform and a DC voltage; and
- The sweep circuit can operate normally with the flyback disconnected in order to test for an overload in the flyback or the high-voltage loads.

These three distinctive characteristics can be the basis of some efficient troubleshooting methods. Whether or not the breaker trips is the best overload indicator for massive shorts. Although a 7-ampere fuse is in series with the circuit breaker, the breaker usually is the one that opens from overloads.

Defects other than the loss of high voltage or focus voltage can cause a loss of raster, so we'll give a few tips about them to start.

### No Raster

Loss of raster can be caused by these general conditions or defects:

- defects of the picture tube, such as open heaters, and other shorts or opens;
- wrong bias of the picture tube, cathode voltages too high (video defect) or grid voltages too low (see Figure 2);
- insufficient picture-tube screen voltages (also Figure 3), the screen controls should adjust to more than +800 volts at the base socket;
- shorted spark gaps or open resistors inside the CRT socket;

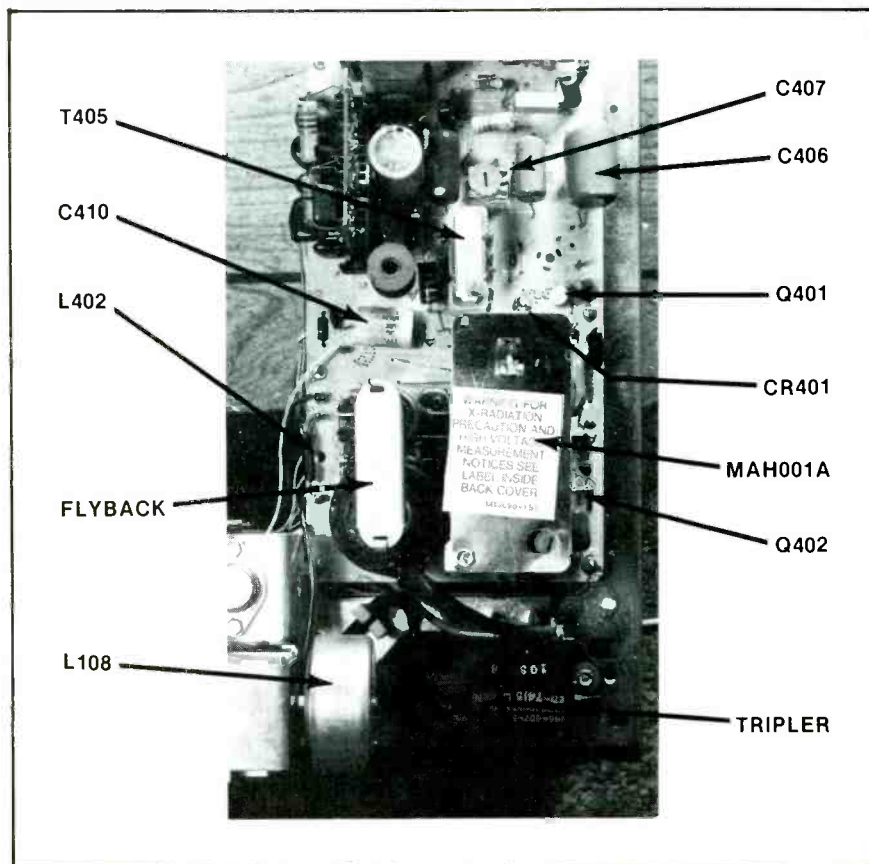

Here are the locations of components often used during troubleshooting of horizontal-sweep problems in the RCA CTC58.



- loss of focus voltage (measure first at "F" terminal of the tripler, then trace through the focus voltage divider); and

- loss of high voltage (after several minutes operation, turn off power and check the tripler for hot spots on the case, that usually indicate internal shorts of a defective tripler).

When both focus voltage and HV are lost at the same time, the next step is to determine whether the sweep or the flyback/HV section is to blame. Other natural divisions of troubleshooting include isolating the defect to the retrace or trace section (when the trouble is not in the flyback/HV section), and whether the defect causes the breaker to trip or not.

Of course, before you get involved in elaborate tests, it's well to do a few preliminary tests. Sometimes the simple checks are enough.

### Preliminary Tests

The anodes (metal cases) of the SCR's and the cathodes of the switching diodes are good test points and easy to locate.

With the power off, measure the resistance from each SCR case to ground. SCR102, the top one, should read around 18K, after the filter capacitors finish charging. (With the positive lead of a VOM or VTVM ohmmeter at the anode, the reading should start at low ohms and gradually increase to the final figure.) Digital meters (or others with "low-power" ohms) might read several hundred thousand ohms, because the low voltage doesn't "turn on" the power-supply diodes.

An infinite or high reading indicates an open between the SCR102 and the +150-volt supply, perhaps in T401 and T402. A near-zero ohms reading proves a short, which might be in SCR102, CR402, C407, or C122. Of course, T401, T402, or L108 might be shorted to the frame (ground), but such defects are very rare. Best bets are SCR102 and CR402, the retrace switches.

The diode switches CR402 and CR401 are soldered to their sockets as a protection against loose connections. Therefore, it saves time to make sure any shorts are actually in the sweep circuits, rather than in the power supply. Remove the B+

## The "New Generation" Flat-Rate Pricing...

is proving itself in thousands of shops from coast to coast—it prices your work profitably while creating customer good-will.

Fast tab indexing to 19 major repair categories prices all bench, home and over-the-counter repairs with authority.

## tv & radio tech's guide to pricing

### Plus, Computerized Pocket-Size Parts Catalog.

Customized to your desired parts profit. Lists over 3500 most-used parts, continually up-dated. Can easily recover initial investment in less than 30 days... \$75.00 plus \$10.00 per catalog.



### Satellite Edition...

the same system described above, only reduced to shirt-pocket size for outside service... \$16.95 ea. post pd. Quantity prices available.



**Professional 6 x 9 hard cover, steel ring-bound edition...**  
\$18.95 ea. post pd.

P.O. Box 5234  
Lincoln, NE 68505

## sperry tech inc.

\_\_\_\_ copies, Hardbound. \_\_\_\_ copies, Satellite  
\_\_\_\_ copies, Parts Catalog.  More information  
\_\_\_\_ Amount enclosed, check or money order.  
(NE res. add sales tax)

NAME \_\_\_\_\_  
CO. \_\_\_\_\_  
ADDRESS \_\_\_\_\_  
CITY \_\_\_\_\_  
STATE \_\_\_\_\_ ZIP \_\_\_\_\_

For More Details Circle (5) on Reply Card

## Get Faster Response For Today's Needs

## Use Electronic Servicing's Reader Service Cards Now!

Electronic Servicing  
1014 Wyandotte  
Kansas City, Mo. 64105

## THE NLS LM-3 VOLKSMETER

World's lowest priced precision digital multimeter -- more accurate and rugged than the old pointer meter -- ideal for field service.



With Rechargeable Batteries & Charger Unit.

**\$125**

### Standard Features:

- Automatic polarity and zeroing.
- Large 0.3" LED display.
- 13 ranges: vac, vdc & ohms with 1% accuracy.
- Size: 1.9"H x 2.7"W x 3.9"D.

Also available in 3-1/2-digit or laboratory quality 4-digit meter. Ask for LM-3.5 or LM-4

See your local distributor!

Distributor inquiries invited.



### Non-Linear Systems, Inc.

Originator of the digital voltmeter.  
Box N, Del Mar, California 92014  
Telephone (714) 755-1134 TWX 910-322-1132

For More Details Circle (6) on Reply Card

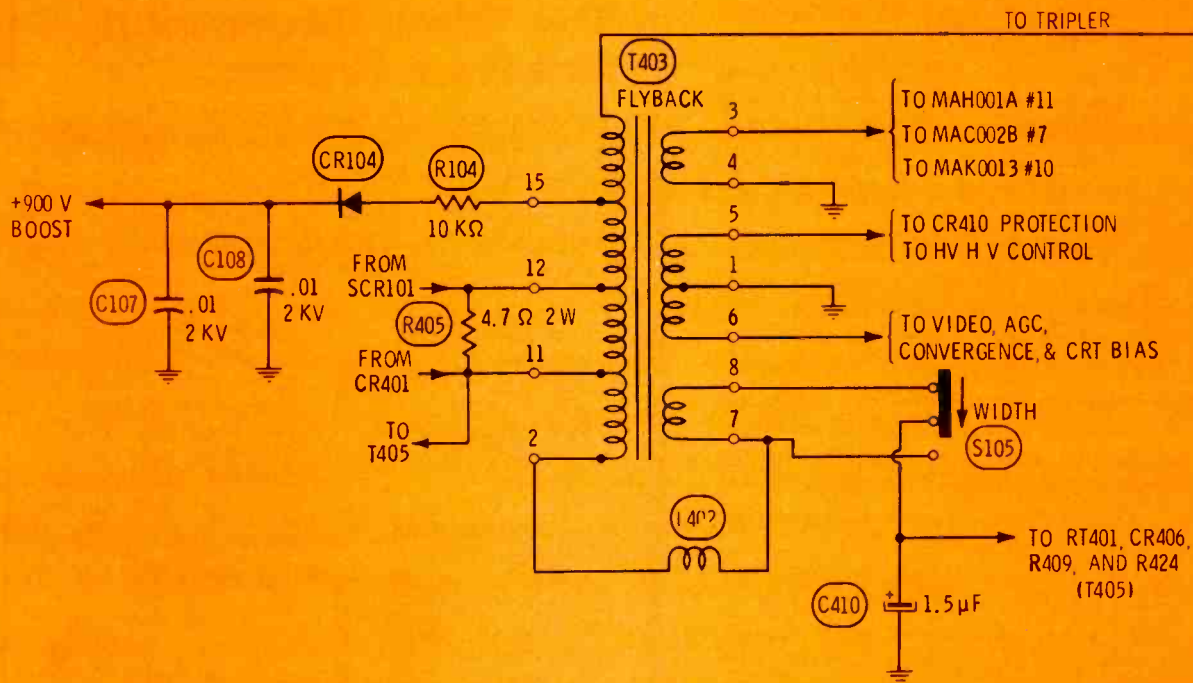

**Fig. 1** Horizontal sweep of the RCA CTC58 produces pulses as a byproduct of the deflection. These pulses enter the flyback at terminals 12 (and 11), and are bypassed to ground at terminal 7 or 8, according to the setting of the width switch. Other windings of T403 step up the pulse voltage for the B-boost rectifier and the HV tripler, and step down the pulses for use in many other circuits, as indicated. The tripler has three output voltages. Two are for the high-voltage and focus voltage. The third (DC) monitors the current, giving a DC voltage that varies from zero with a black raster to about -4 volts at maximum brightness. This negative voltage subtracts from the forward bias of Q302, increasing the collector voltage and the positive voltage at the brightness control. Voltage from the brightness control goes to terminal 10 of module MAL001B, where a more-positive voltage decreases the brightness, preventing excessive picture tube current.

wire from the terminal just behind CR403 (below the yoke plug) to prove which part of the circuit has the short.

With the positive lead at the anode of SCR101, the usual resistance reading is about 80K. Most of this is leakage through C410, C120, C121, and the load at the output of CR104. A low resistance might indicate a short in one of those components; however, SCR101 and CR401 (trace switches) are more likely to be shorted.

### Preliminary Power Tests

If the resistance tests show no certain shorts, then power can be applied. First, you should notice whether or not the breaker trips. If it doesn't trip, can you obtain any kind of raster? Or, if the breaker

does trip, is the overload in the retrace side or the trace side of the circuit? The sequence of tests is different for each of these basic conditions.

### Incorrect Raster

Only a few kinds of defects permit an abnormal raster. A narrow raster with severe foldover usually indicates an open CR402, CR401, or SCR101. Loss of gate drive to SCR101 gives about the same symptoms, too. Pictures of the raster with those defects were shown last month.

Narrow raster, without noticeable distortion, can occur from certain overloads or shorts at taps of the flyback (such as terminals 4, 5, 8, 6, and 15).

In contrast to tube circuits, there

are few malfunctions that give a slightly-narrow width.

### No Raster, No Overload

Remember to check the list previously given for things that can cause a loss of raster. These can trick you into believing the basic problem is loss of high voltage.

### Scope waveforms

In a previous article, I said the waveforms at the anodes of SCR102 and SCR101 were not very informative. That's true; however, the waveforms **must** be there. So, they are useful for preliminary, fast checks.

If full B+ is measured at the anode of SCR102, but neither SCR102 or SCR101 has any waveforms at their anodes, it's likely that SCR102 is open, or that drive is not reaching the gate of SCR102.

Lack of drive there could be caused by a defective MAH001A horizontal-oscillator module, or the SCR might have a gate-to-cathode short. A strong, broader waveform at the gate (see Figure 3), but no negative DC, is proof the SCR gate is open. If both the waveform and the DC voltage are okay, perhaps the SCR has an open anode.



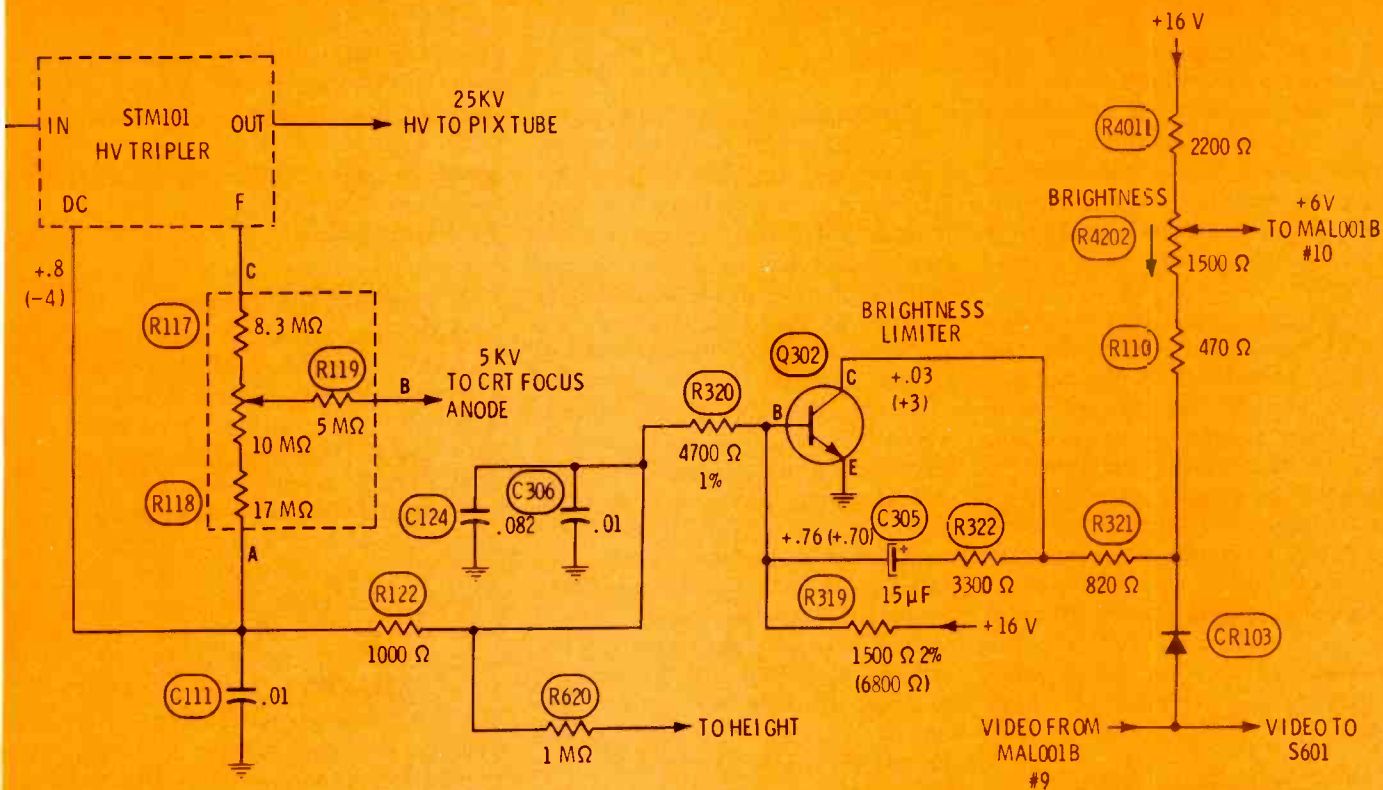

A near-zero resistance from gate-to-ground probably means a shorted SCR. Of course, the normal SCR gate resistance is low, in both polarities, as we shall explain in the section about testing SCR's.

### Retrace Okay, Dead Trace

As a test, you can add a jumper from the trace side of C406 to ground of a normally-operating set, turn on the power, and notice the symptoms. Of course, there's no sweep, high voltage, or raster. But, strangely enough, the breaker does not trip, and the SCR's and other components **don't** run warm. No waveform appears at the anode of SCR101, but there is one at the anode of SCR102 in the retrace section (Figure 4).

A careful analysis of the waveform shows that the trace time is lengthened, the retrace time is shortened, and the repetitive frequency is lower (perhaps around 12 KHz). The lower frequency results from the lack of pulses to the horizontal-phase detector, which normally come from the flyback.

B+ and the waveform at the anode of SCR102, when the trace side is grounded is proof the retrace circuit is okay, and the problem is

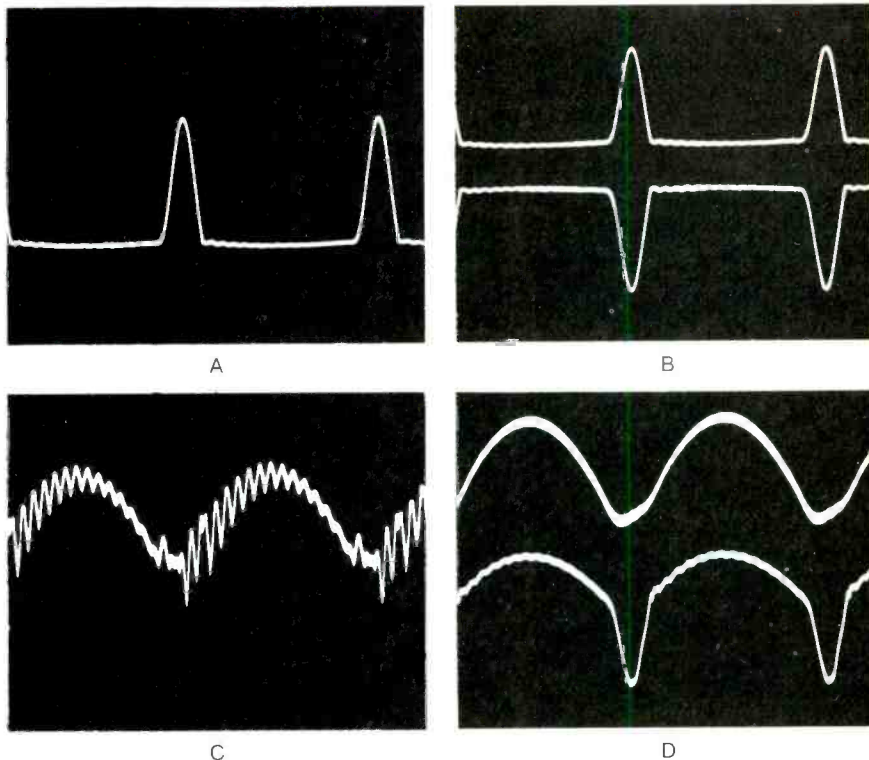

**These waveforms** are the normal ones at the flyback transformer, T403. (A) 30 volts PP of positive pulses are at terminal 3. (B) Top trace shows the positive-going pulses (30 volts PP) at terminal 5, and at the bottom are the 160 VPP of negative-going pulses at terminal 6. (C) At terminal 2 is this 12 VPP waveform; the ringing probably is caused by L402. (D) These two waveforms vary according to the position of the width switch; in this case the switch connected C410 to terminal 7 for a narrow picture. Top trace is the almost-parabola at terminal 7 (about 12 volts PP). In the bottom trace, negative-going pulses are added to the parabola, producing this 15 VPP waveform at terminal 8.

likely to be in the trace or flyback/HV section.

**One precaution: don't ground the trace side by using a screwdriver blade, or something similar.** Such a ground has a high probability of being intermittent, and intermittents might trip the breaker or cause failure of some of the components.

This same grounding test is very useful for proving whether the overload (which causes the breaker to trip promptly at turn-on) is in the retrace section, or on the trace side. If the breaker continues to trip with the jumper installed from the cathode of CR401 to ground, the defect is in the retrace circuit. But, if the ground stops the breaker from tripping, and the waveform is at the anode of SCR102, the problem is in the trace side, including the flyback or high voltage.

### Defective L108

When L108 has shorted turns, the breaker trips immediately at turn-on. This is true both when the trace side is grounded, or if it is not. On the other hand, an open coil stops the sweep, but there's more than +165 volts and the

waveform of Figure 5 at the anode of SCR102.

### Operation Without Flyback

To operate the horizontal-sweep circuit and yoke, but without the flyback, it is necessary only to disconnect C410 (in Figure 1, it's wired from the center lug of the width switch to ground), which is located just above the flyback.

**Caution:** reduce the line voltage to the receiver anytime you test with the flyback disconnected. About 90 volts AC is recommended. However, I have made the test several times, for a few seconds each, by using an "up 10/down 10" transformer to supply 105 volts. No damage occurred to any components during those tests.

Then connect your scope to the cathode of CR401. If the breaker had been tripping before C410 was opened, but now the scope shows normal HV pulses, and the breaker holds, the overload is in the flyback, or beyond.

One winding of the pincushion transformer (T405) is wired between terminal 11 of the flyback (which also goes to CR401) and C410. Therefore, disconnecting C410 opens the pincushion circuit. Short-

ed turns in T405 will act exactly the same as shorted turns in the flyback. Disconnect this winding of the pincushion transformer, replace C410 and try to operate the receiver. Normal operation (except for no pincushion correction) proves T405 is defective.

### Testing the Flyback

Testing the flyback of the CTC58 in-circuit is rather difficult. One method is to ring it with fast-rise-time pulses and analyze the pattern on a scope. However, the ringing should not be done with ground as one terminal. Evidently, C410 interferes. It's best to connect to terminals 12 and 8 (see Figure 1). Unexpectedly, little difference was observed whether the yoke, convergence, retrace circuit, or SCR101 and CR401 were left connected or not. The low-impedance of the flyback windings require a large ringing capacitor, and this reduces the circuit "Q" so much that minor shorts seem to make little difference. However, L108 and the yoke ring very well if they are disconnected first.

Terminal lugs of the flyback are soldered into metal eyelets that are a part of the circuit board, making the removal for testing a bit tedious. So, try to be certain the flyback is bad before you remove it.

Perhaps the most infallible test is to disconnect one load (such as CR104, CR410, or the tripler, for example) at a time, noticing which brings back the raster or shows the proper retrace and trace waveforms at the SCR's. (Even that test is complicated by the many circuits connected by "printed" wires.)

### HV Regulator And Protective Circuits

If the main symptom is wrong horizontal frequency, and the hold control can't lock the sweep (or cross the right frequency), the high voltage might be excessive, or the over-voltage protective circuit might be defective.

The first step is to measure the HV at the picture tube. If it's too high, troubleshoot the HV-regulator circuit. But if the HV is normal or slightly low, suspect the horizontal-oscillator module or the protective circuit. Remember that excessive Q402 collector current is supposed to reduce the oscillator frequency.

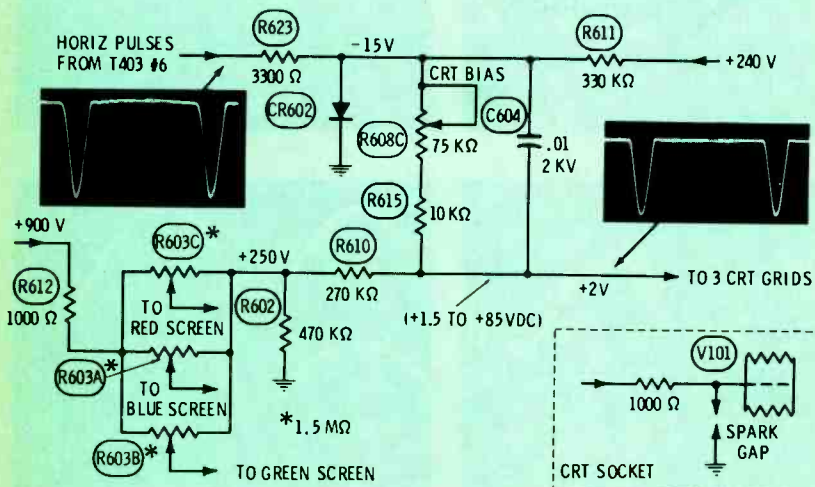

Fig. 2 This circuit provides adjustable DC voltages for the three picture-tube control grids and the three screen grids. CR602 produces a small amount of negative DC voltage by shunt rectification. R608C, the CRT Bias control, regulates how much negative voltage is mixed with positive voltage from R610 to furnish the control grid voltage. Most of the negative-going pulses travel through to the grids to become additional horizontal blanking. The low ends of the screen controls tie to the grid bias to stabilize these voltages. Isolation resistors and spark gaps are connected to most pins inside the picture tube socket.



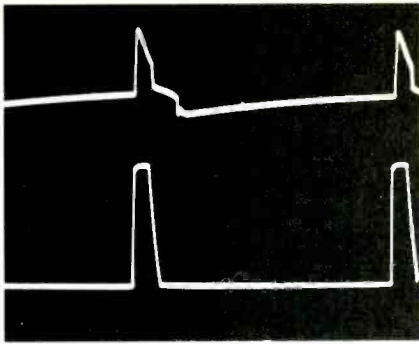

Fig. 3 Correct waveform for the gate of SCR102 is shown by the top scope trace. If the waveform at bottom, without any negative DC voltage, is found at the gate, the gate/cathode junction of the SCR is open.

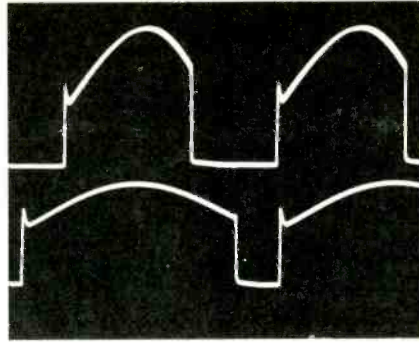

Fig. 4 Top scope trace is the normal waveform at the anode of SCR102. If the "trace" side of the sweep is not operating, the waveform will resemble the one at the bottom.

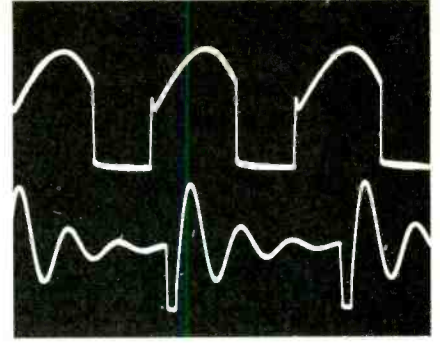

Fig. 5 If L108 is open, there will be no sweep or high voltage, but the breaker will not trip. Top scope trace is normal for the anode of SCR102, and the bottom waveform is present when L108 is open.

So, as a first test, ground the base of Q402. If the hold adjustment can then lock the horizontal, the oscillator module is cleared of suspicion. The HV regulator is implicated, if the HV is too high; or the Q402 circuit should be tested more, if the HV is not too high. (This test can't show a C/E short in Q402.)

In the same way, grounding the base of Q401 (HV regulator transistor) should increase the HV (a good test for weak HV), and force the Q402 circuit to change the frequency. Sometimes, it's helpful to ground the bases of both Q401 and Q402 until the trouble is located.

A C/E short in Q401 usually will trip the breaker because of extra load on the +75-volt supply. If this is suspected, the transistor should be removed and tested. While it is out, operate the chassis. Normal operation with excessive HV proves the transistor current was too high.

As you can see, there are many combinations of troubles and tests for these two circuits.

### SCR Current

The drawing in Figure 6 shows the approximate waveshape and amplitude of the current of the switching SCR's and diodes at the various times according to the yoke current. This information supplements the scope waveforms on page 47 of February *ELECTRONIC SERVICING*, and it gives some clues about the origin of any vertical lines (similar to Barkhausen, and caused by SCR or diode switching currents) which might appear on the TV screen.

### Testing SCR's

Some semi-conductor testers also can check SCR's. If you have the equipment, test any suspected ones that way.

However, simple measurements with an ohmmeter are quite reliable. A normal, non-defective SCR should measure the same resistance from gate to cathode, regardless of the polarity of the ohmmeter's battery. The exact reading depends on the kind of meter and what scale is selected. For example, my "Old Faithful" VTVM reads about 80 ohms on the X10 scale for either polarity of test leads. That's similar to a pair of paralleled diodes of opposite polarity.

Other than gate/cathode conduction, the other readings should

be near infinity. Specifically, gate/anode and anode/cathode should measure about the same as the leakage (reversed polarity) of silicon power-supply diodes (several hundred thousand ohms, or higher); and the readings should be about the same when the test leads are reversed.

In other words, **any non-defective SCR should check open, except between gate and cathode.**

### Comments

Your own troubleshooting skills, plus these suggestions for pinpointing defective components, should enable you to find most troubles in SCR horizontal-sweep circuits without undue difficulties. □

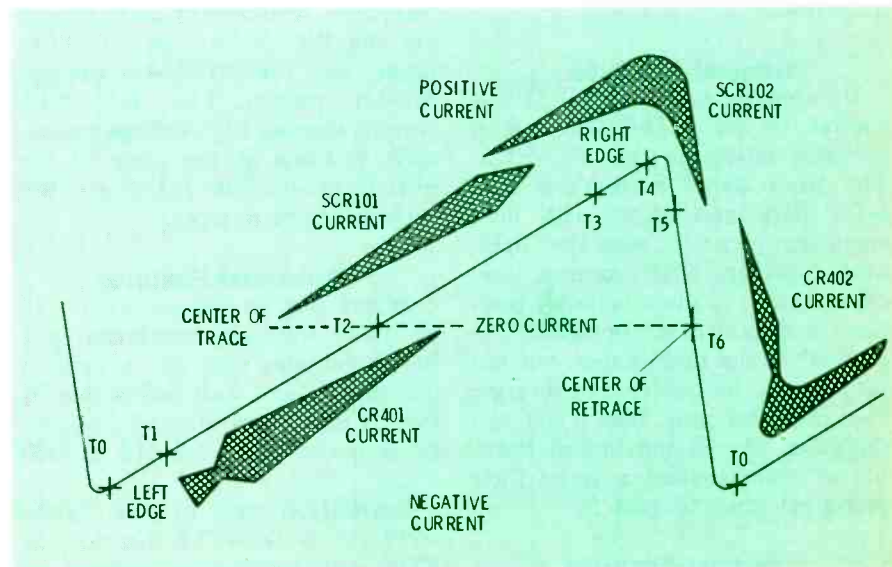

Fig. 6 Current waveforms of SCR102, CR402, SCR101, and CR401 from the February article have been drawn as they contribute to the yoke current at the times marked for one complete cycle.

RCA WO-33B 3' scope is shown testing a transistor junction without requiring additional wiring or equipment.



# Reports from the test lab

By Carl Babcoke

*Each report about an item of electronic test equipment is based on examination and operation of the device in the ELECTRONIC SERVICING laboratory. Personal observations about the performance, and details of new and useful features are spotlighted, along with tips about using the equipment for best results.*

## Small Scope With Extra Tests

The RCA Model WO-33B has all the regular features of recurrent-sweep scopes, plus small size for easier transportation, and **three** additional major test functions built-in. Internal circuitry similar to that of the RCA WC-528C "Quicktracer" shows right-angle waveforms for good junctions of transistors and diodes. Terminals and switch positions provide vector "petals" for adjusting color-TV receivers, and deflection pulses come from a jack on the side for ringing tests of deflection inductances.

## General Features

In appearance, the WO-33B is similar to the WO-535A, and it operates much as the WO-505A. The front panel is marked with satin black and white, with lines enclosing controls normally operated together. CRT controls are: off/intensity; focus; vertical position; and horizontal position. The graticule is not illuminated, but has calibrations for vectors, calibration lines, and two scales (one 5 volt and the other 15 volt maximum) showing in white against a green filter and green trace (Figure 1).

## Vertical Features

Eight positions plus calibrate are furnished by the "vertical range" control. The three most-sensitive

ranges (.05, .15, and .5 volts PP full scale) are narrow band, with specifications of 20 Hz to 150 KHz at -3 dB.

Response of the five wide-band ranges (1.5 to 150 volts PP) is 3 Hz to 5 MHz at -3 dB, and usable to 10 MHz (Figure 2).

The "V cal" control functions either as an adjustable gain control or as the calibration control, used to adjust the height of the calibration signal to fill the space between the marks.

A WG-400A direct/low-capacitance probe with BNC connector is furnished. Available at extra charge are the WG-302B signal-tracing probe, and the WG-354A voltage-divider probe. The WG-354A permits viewing high-voltage pulses, such as those at the plate of the horizontal-output tube, or the cathode of the damper.

## Horizontal Features

When used for vectors (Figure 3), or other lissajous patterns, the horizontal amplifier has a gain of 2.5 volts PP per inch (adjustable by the "H gain" control), and frequency response from 3.5 Hz to 350 KHz.

Repetition rate of the sweep oscillator is from 3.5 Hz to 350 KHz, with variable adjustment by the "sweep vernier" control, and selected by a "function" switch having six ranges, including one for

"Quicktrace", and another for "line". The line function is for sweep alignment using 60-Hz sine-wave scope sweep, and the phase is adjustable by the "sync/phase" control.

For the usual sawtooth sweep, sync phase and amplitude for locking are determined by the "sync/phase" control. Zero sync amplitude is at the center, counter-clockwise rotation increases the amplitude of negative sync, while clockwise increases the positive sync. Normal (internal) or external sync is selected by a two-position switch labelled "sync/normal".

## Quicktrace

Internal circuitry, with a panel switch and jack, allows testing transistor and diode junctions by showing conduction on the scope screen. The method was described thoroughly starting on page 31 of the November, 1973 issue of ELECTRONIC SERVICING (for the RCA WC528C Quicktracer), and will not be detailed here.

AC is applied to the junction. No conduction causes a horizontal line, and conduction produces a vertical line. Therefore, a normal diode produces both, in the shape of a right angle. Whether the vertical part of the trace goes up or down depends on the polarity of the junction and of the test leads. Figure 4 shows the base/emitter pattern of a NPN silicon transistor. The double vertical lines show zener action (normal forward-bias conduction, and reverse conduction at the zener voltage). **This is one positive proof of a silicon B/E junction; only silicon, and only B/E, give the zener pattern.**



## Ringling

The front panel of the WO-33B gives no indication that provision is made for ringing tests. Pulses for ringing come out of a jack on the right side of the case. Just connect the test lead (supplied) to the hot lead of the direct/low-capacitance probe. Then connect the inductance to be tested between ground and the test-lead/probe combination. Adjust the function switch and the sweep vernier for the frequency that's best for ringing the particular component, and adjust the vertical height as needed for a normal ringing pattern.

One peculiarity was noted with the WO-33B, as shown by the ringing waveform of Figure 5. The first few rings were not sine waves, but the trace doubled back on itself. It seemed impossible for any scope to give such a result. But, some experiments of inserting various resistances in series with the inductance proved it was caused by the ringing signal feeding back through to the sweep (which supplied the pulses) and distorting the sweep waveform. In any event, the strange waveforms do not interfere with any conventional ringing tests.

Because it's difficult to know the horizontal-sweep frequency used for ringing, any final judgement of an inductance should include an out-of-circuit test of a new component versus the suspected one.

## Comments

Normal scope functions of the RCA WO-33B instrument were easy to do, as is usual with RCA equipment. Locking was better than that of many other recurrent-sweep models.

Frequency response was adequate

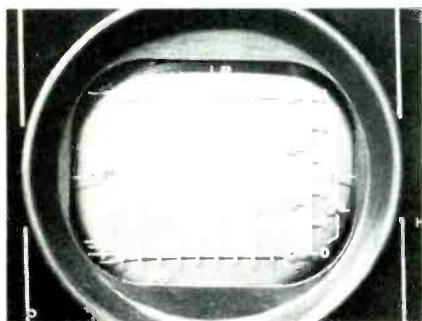

Fig. 1 The green filter in front of the CRT has vector markings, calibration lines, and two PP voltage scales in white.

for all normal measurements in color-TV circuits, on the wide-band ranges.

Having the test leads supplied, and the special hookups made automatically by the front-panel switches, gave speed and convenience for the vector, solid-state junction, and ringing tests. This should encourage the user to make these tests more regularly.

## VOM For Solid State

Although RCA lists the WV-531A meter (Figure 6) for "industrial maintenance and appliance testing", it also has valuable uses with solid-state circuits.

## General Features

Features of the WV-531A meter include:

- taut-band meter movement, diode-protected winding, and mirror scale (line up pointer and image of pointer in mirror to eliminate parallax);
- LED probe for testing continuity without the meter;
- internal shunt and meter scale for testing AC shock-hazard current;
- thermistor probe and meter calibration to test temperatures up to 500°F; and
- measures DC/AC voltages, DC current, and resistances up to 1 megohm.

## DC-Voltage Measurements

Four DC-voltage ranges are provided, (.05, .5, 5, and 50) at 20,000 ohms per volt and an accuracy of  $\pm 3\%$  full scale. The low ranges are fine for testing transistor biases, while the higher ones can determine collector and power-supply voltages. Although 50 volts DC is not high enough for testing tube circuits, an external resistor could be added for an occasional test. For example, the meter resistance for the 50-volt range is 1 megohm. Just add 9 megohms at the end of the test probe (and one zero to the meter reading) to change the range to 500 volts.

## AC-Voltage Measurements

Full-scale AC voltage ranges are 50 volts, 150 volts, and 500 volts at an accuracy of  $\pm 4\%$  and a sensitivity of 9,000 ohms per volt. These ranges are adequate for testing AC input to power rectifiers, and line voltages.

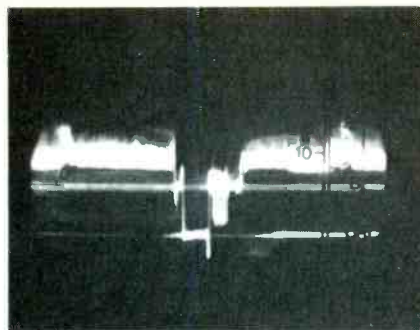

Fig. 2 Good bandwidth and adequate sharpness of trace are shown by this video waveform.

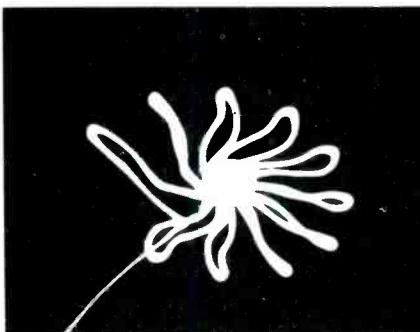

Fig. 3 A separate "vector probe" jack on the front panel gives access to the horizontal-sweep circuit to permit vector displays.

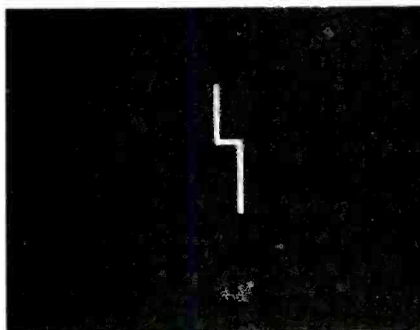

Fig. 4 This is the "Quicktrace" waveform of a non-defective zener or B/E junction of a silicon transistor. Other junctions appear as right angles. Circuit resistances or leakages slant the lines, and capacitances make ovals or circles.

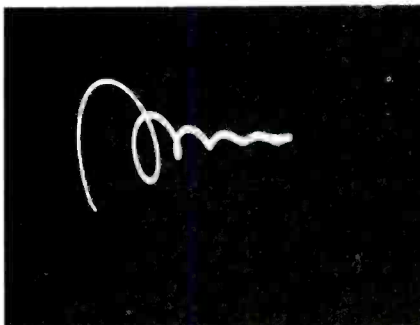
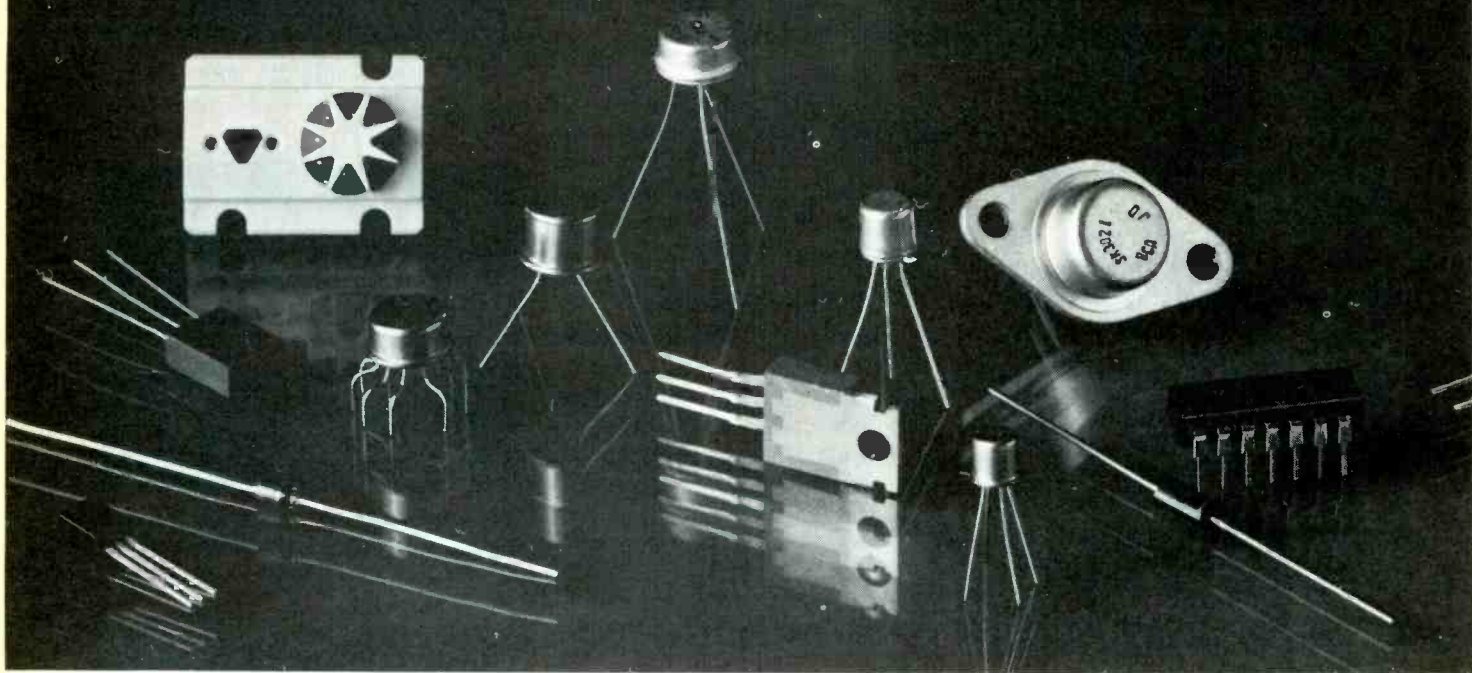

Fig. 5 Ringing tests can be made without additional equipment. The waveforms are unusual, but the shape does not detract from the accuracy.

# Now you can stock only 300 semiconductors instead of 112,000.



### DC Current

Two DC current ranges are provided (50 and 500 milliamperes full

scale) at an accuracy of  $\pm 3\%$ . These can test output transistor current.

### AC Current

AC currents from zero to 1.5 amperes can be measured with this one current range.

### Resistance Measurements

R1, R100, and R1000 ranges permit checking of resistances between .5 ohm and over 1 megohm, with an accuracy of  $\pm 3\%$  full scale. These ranges cover the values of most resistors used in transistorized circuits. And the 3-volt ohmmeter battery strongly "turns on" diodes and transistor junctions for forward-conduction tests. The common lead is negative, and the + lead is positive. A .5-amp fuse protects these ranges.

### AC Leakage

The "AC leakage" position of the range switch parallels the test leads with 1500 ohms and .15 microfarads to fulfill the specifications for the government shock hazard tests. The meter scale is calibrated up to 1 milliampere AC, with marks at .5 and .75 milliamperes. To test, connect one lead to earth



Fig. 6 RCA WV-531A portable volt-ohmmeter also tests temperatures, has an LED continuity probe, and checks shock-hazard leakage.





**With RCA's SK Series** you need stock fewer different semiconductors than you'd have to with any other major brand. Because our 300 devices can replace 112,000. And they're all immediately available.

**OEM Quality.** You don't have to be concerned about quality with RCA SK's. They measure up to strict AQL Standards to protect you from time-wasting callbacks. Lets you make more calls. And more profits.

**See your RCA Distributor** for a copy of the new RCA SK Replacement Guide. Or send \$1.00 to RCA Distributor and Special Products Division, P.O. Box 85, Runnemede, N.J. 08078. Phone: (609) 779-5735.

**RCA SK Replacement Semiconductors**

ground, and the other to the equipment in question.

### Temperature Readings

Calibrations of the temperature scale are from zero to 500°F.

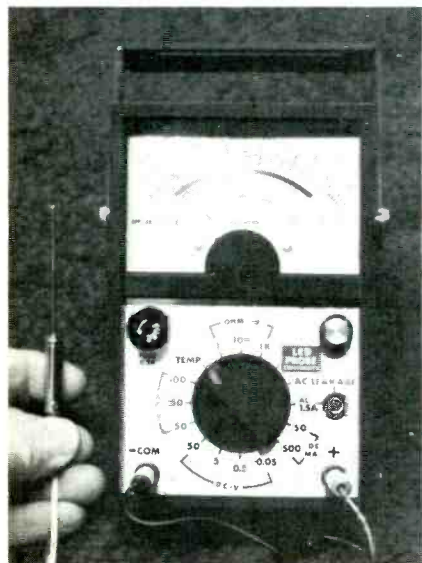

Fig. 7 The metal thermistor probe is waterproof. Temperatures from about 60°F to 500°F can be measured.

Although the lower end of the scale is compressed, readings down to about 60° should be possible with fair accuracy (overall accuracy is  $\pm 3\%$  of full scale). Probably this range was selected for measuring the case temperature of motors and the soleplate temperature of irons, but it should be okay for checking the temperature of output transistors.

The thermistor probe (Figure 7) can be immersed in liquids, or taped to the case of a transistor.

### LED Probe

A red LED is mounted in the top end of the LED continuity probe (Figure 8). Therefore, low-resistance wiring can be tested without looking away from the probe. Some glow could be seen in a well-lighted room with as much as 5K resistance across the test leads.

### Comments

Factory suggestions for using the meter include measuring the tiny DC voltages from furnace and oven thermocouples, and checking the



Fig. 8 A red LED in the end of the continuity probe lights to show resistances of less than about 5K ohms.

shock hazard of electric drills. But many other uses for the ranges provided in the RCA WV-531A industrial and appliance meter occurred to me. Most measurements needed for low-voltage transistor circuits can be made during shop repairs of radio or stereo equipment. And the leakage function can be valuable for service calls, with the other ranges useful for the kinds of superficial tests done in the homes. □

# SHERLOCK OHMS AND THE ELECTRONIC PUZZLE!

by Edmund A. Braun

Be a Doctor Watts-on and have fun helping Sherlock Ohms solve this Just-across-word Puzzle based on Electronics. Each word is connected to the word above and below by one or more letters although only one is usually shown as a clue. Each correct answer is worth 4 points; a perfect score is 100. It should be fairly easy to get a high rating except perhaps for someone who thinks "broadside array" is a fat woman in slacks, or that "dry battery" is a baseball pitcher and catcher wanting a beer! Sharpen your pencil and your wits, and GO!

- 1 Volume of electric current.
- 2 Phenolic compound having good electrical resistance.
- 3 A basis of uniformity.
- 4 Appearance of a type of paint when it dries on cabinets or panels.
- 5 British term for radio.
- 6 Being perpendicular to the horizontal.
- 7 Having the nature of glass.
- 8 Pertaining to a relay that requires two pulses to complete one cycle composed of two conditions of operation.
- 9 To put or fit together.
- 10 Speakers designed for the reproduction of treble frequencies.
- 11 Measuring unit for wavelength of light or other radiation.
- 12 Metal used in the manufacture of tube filaments, etc.
- 13 No longer in use, usually because of newer and better developments.
- 14 An oscillator in which the grid and plate circuits are inductively coupled.
- 15 Circuit serving simultaneously as oscillator and heterodyne detector.
- 16 Distorted TV picture which appears to overlap horizontally or vertically.
- 17 An increase in the size of the scanning spot on a CR tube.
- 18 Alloy wire with qualities ideal for precision wirewound resistors.
- 19 To disconnect or detach.
- 20 Centimeter-gram-second electromagnetic unit of current.
- 21 Applying insulation to wire by serving tape around the conductor.
- 22 Early term for current resulting from chemical action.
- 23 Type of screw with an indented cross in its head.
- 24 Pertaining to a connection of two or more devices in parallel.
- 25 A wow or drift; frequency deviation produced by irregular motion of a turntable.

Another clue: You'll find the solution on Page 48.

EDMUND A. BRAUN





Portable phonographs come in all sizes from single-speed children's models to larger versions with elaborate record changers, such as this one that has a speed adjustment.

# TIPS FOR REPAIRING PORTABLE PHONOS

Part 1/By Carl Babcoke

*Probably no other kind of electronic device is mistreated so badly as the typical portable phonograph. Therefore, the service problems seem to follow a pattern of defects, regardless of the make or model. Here are some tips for making fast repairs of these machines.*

Many portable phonographs can be repaired without the removal of the record changer or the amplifier. That's because the majority of problems involve the motor, the tone arm, or the cartridge; and usually they can be reached from the top.

Therefore, we will give some shortcuts and "tricks of the trade" for fast repairs, and not explain in detail the workings of record changers, or the theory of audio amplifiers.

## Displaced Stylus

Styli (formerly called "needles") must be small of mass and easy to move, else they have poor frequency response, and might jump out of the groove when the record volume is loud. However, this ease of movement (called compliance) makes the stylus susceptible to physical damage.

Typically, a phono listener doesn't clean the stylus regularly, but waits until the ball of dust and lint has become large enough to lift

the cartridge from the record at times, causing skips, or a tinny sound with distortion. Perhaps then the customer attempts to remove the dirt by using a match, kitchen knife, or a fingernail.

The result of this do-it-yourself project is a stylus pushed out of its yoke, a broken stylus, or one bent beyond any further use. Perhaps your repair of such damage will require only seating of the shank of the stylus in the groove of the linkage which connects to the two ceramic elements (of a stereo cartridge, as shown in Figure 1).

Or, the cartridge might be completely ruined (Figure 2).

## Fast stylus tests

Borderline cases of bent or displaced styli, not fitting securely in the linkage, sometimes can be identified by playing a record while you gently press right or left against the side of the tone arm near the cartridge. If the distortion or scratchy sound is improved, either the stylus is out of the groove in the

# 25 Invitations to great reception.

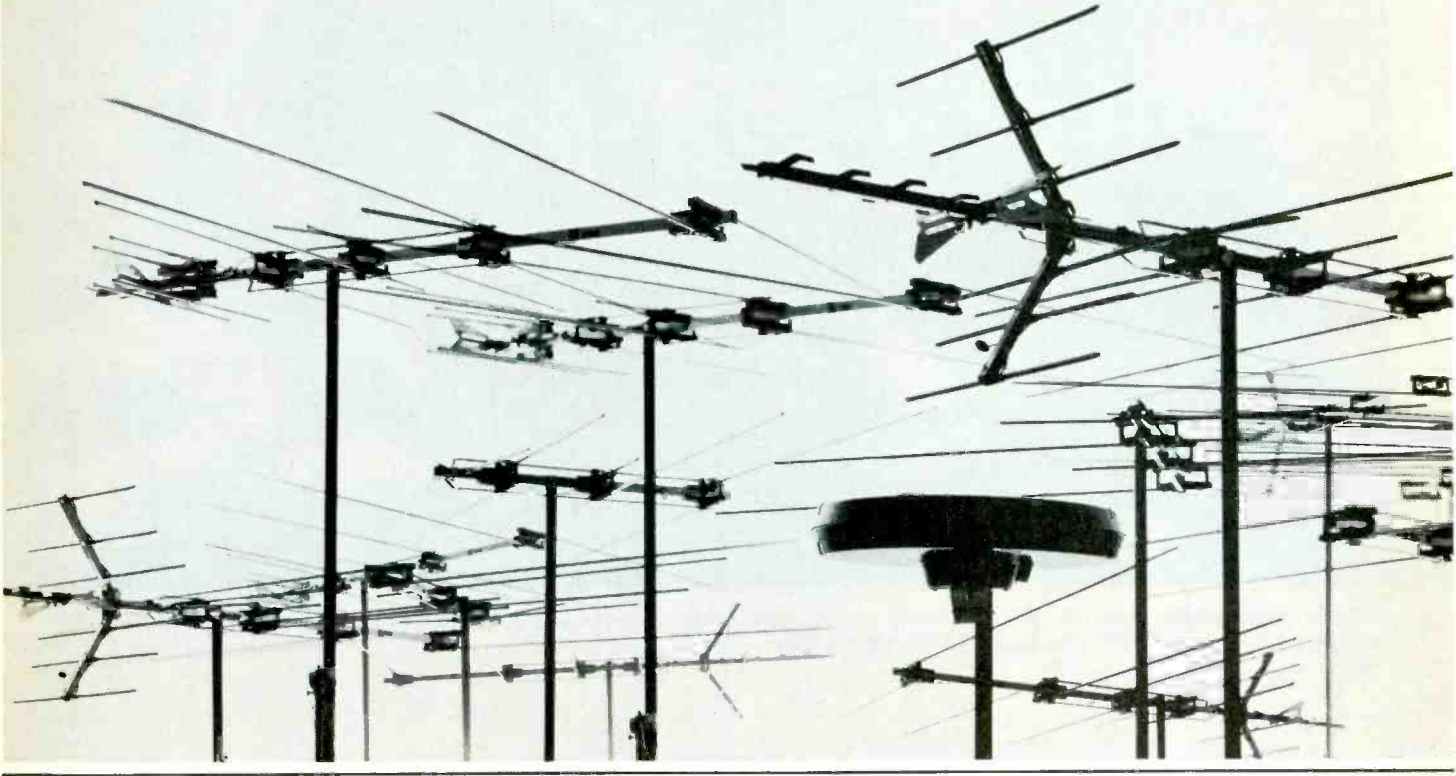

linkage, it is bent so it contacts one side only, or one of the ceramic elements is cracked.

For another test, place a dime or nickle on top of the arm above the cartridge, while a record is playing. With a normal cartridge and

correct stylus pressure, there should be no difference of tone quality. But if the music sounds better, the pressure is not sufficient, or the stylus assembly is bent or defective in some way.

A record that falls at the wrong

time when the arm is below it, or transportation of a player without the tone arm fastened securely, can chip off part of the tip of a stylus. That's true for both sapphire and diamond tips. Diamond tips are highly-resistant to normal wear, but

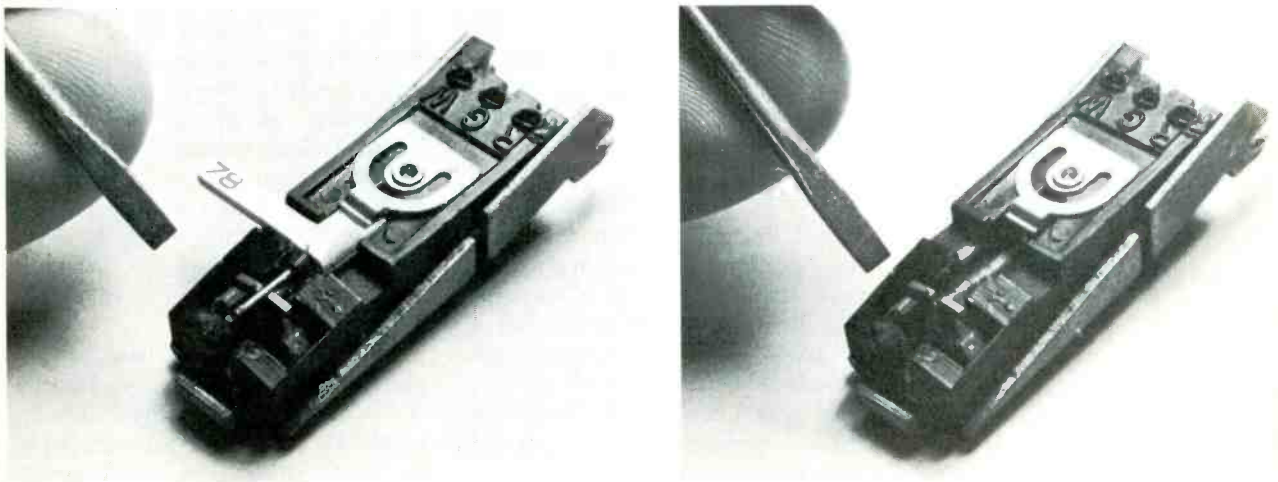

**Fig. 1** The shank of this flip-over stylus (left picture) is held in a groove of the linkage, which moves the ceramic elements. In the right picture, the stylus assembly has been removed. Always be sure the stylus shaft fits properly in the groove of the linkage.



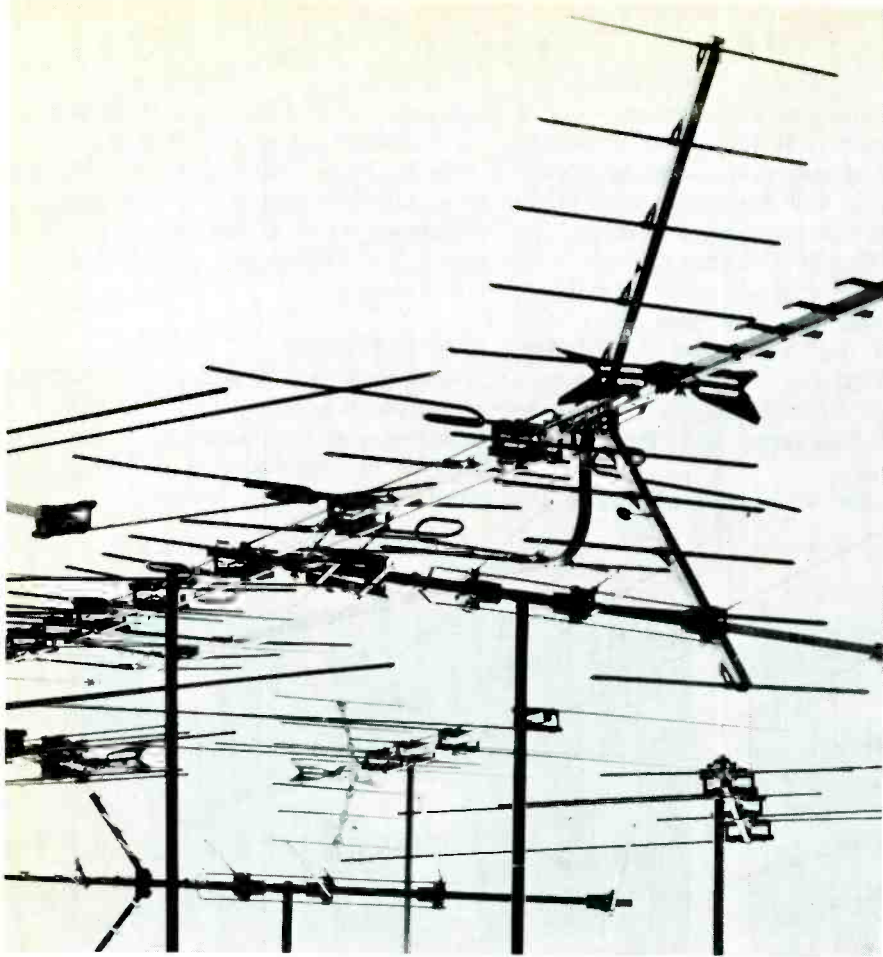

**Outdoor antennas, for sure.** For UHF, VHF and FM — and almost any combination. Plus Mini-State — RCA's newest and most advanced miniature rotating antenna for the best possible reception in apartments, homes, boats, trailers and RVs.

**We don't stop there, either.** Our line of great rotators for outdoor antennas, our reception aid amplifiers, splitters, transformers, and our easy-as-pie mounting hardware, give you the most complete line of invitations for great reception anywhere.

**RSVP.** For all the details, see your RCA Distributor — or contact RCA Distributor and Special Products Division, Cherry Hill, N.J. 08101. Phone: 609-779-5763.

**RCA** Permacolor  
Outdoor Antennas

they're brittle.

If the tone arm sets down okay, but then slides across the record, it's likely the tip of the stylus is missing entirely, or the whole stylus might be gone.

When the tip of a stylus has flat sides worn by playing too many records, audible distortion and excessive record wear are the results. In extreme cases, this distortion imitates amplifier distortion. I'll never forget the first time I heard such distortion from the stylus; I was **positive** the output tubes were running with zero bias!

Although the scientific method of evaluating the tip of a stylus is to examine it using a 25X or 50X microscope, there is a simpler way that works well in a surprising number of cases.

Just gently lower the arm on top of your upturned index finger, and **feel** the tip of the stylus. Try this test with a few non-defective styli, and you will soon know what to expect. A tip that feels **too** sharp, probably has a chip. A tip without

sufficient sharpness might be worn out.

#### Set-down position

Before you attempt to adjust the needle set-down point (indexing), make sure the stylus and cartridge

are in good shape, and the stylus is in the correct position. If you re-index first, then make stylus repairs that affect the position of the tip, the indexing will have to be done again.

Many record changers have a

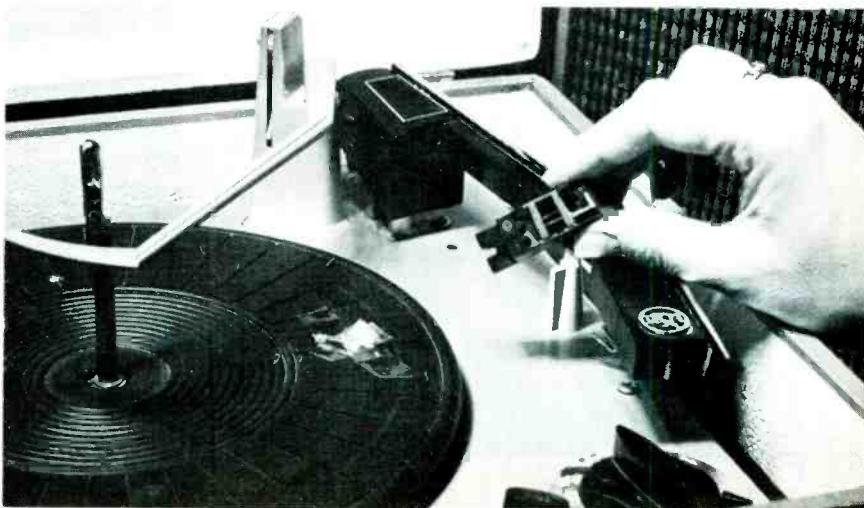

Fig. 2 A customer ruined this cartridge while trying to install a new stylus. The stylus and mounting screws have been taped to the turntable.

hole in the baseplate (located almost back to the tone-arm-mounting mechanism) that can be used for indexing. At a certain time during the change cycle, a cam with a screwdriver slot is positioned just under this hole.

Operate the changer by running the motor, start the change cycle by using the reject knob, then turn off the power. Move the turntable by hand until the tone arm swings to the side and then back toward the record. Slowly rotate the turntable

until the arm stops moving toward the center. It should be above the edge of the record, and additional rotation will lower the arm. Don't rotate the turntable any more. The cam should be under the hole now, so insert a small screwdriver blade through the hole and find slot. Turn the cam about 1/8th turn, then test the indexing by allowing a record to drop and the machine to lower the arm into the starting groove.

If the adjustment has made the

indexing error worse, go through the procedure of rotating the turntable by hand. But at the proper time, turn the cam in the opposite direction. After a few tries, you should be able to find the correct adjustment.

#### Buzz tests for gain

Terminals and contacts on the underside of a phono cartridge can be convenient test points for quick tests of the approximate amplifier gain.



**While a record** is playing, gently apply a slight pressure against one side and then the other of the tone arm. A defect of stylus or cartridge is proved by better tone quality during the test.



**A small coin** weighting down the tone arm is another simple test. If the tone quality improves and the distortion decreases, more stylus pressure is needed, or the stylus/cartridge is bad.

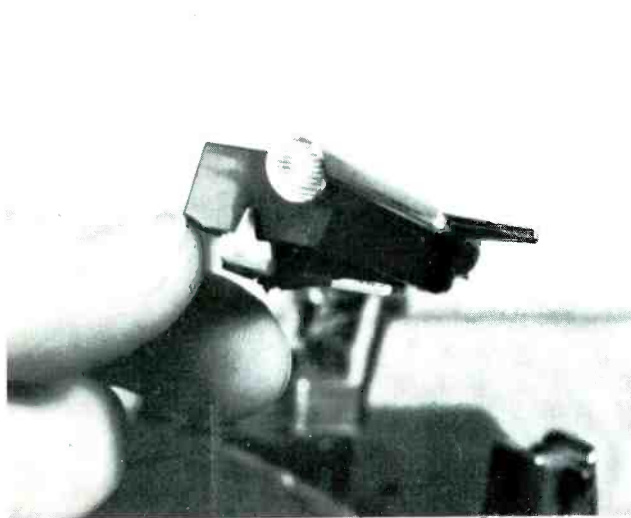

**Feel the point** of the stylus with the tip of an index finger. A stylus that's too sharp, or not sharp at all, indicates a problem with the stylus.



**Adjustment** of indexing (where the stylus tip touches down near the starting groove) for many changers can be done with a small screwdriver, through a hole in the baseplate, as shown.



# READER SERVICE CARD Electronic Servicing

Use the handy card below to obtain free catalogs and literature . . . and to subscribe or renew your subscription.

Read instructions carefully.

As a service to its readers, ELECTRONIC SERVICING makes the card below available for your convenience in obtaining current manufacturer's literature.

To use the card, simply:

- Circle the numbers corresponding to the numbers of the items about which you would like to receive additional information.
- Print your name and address and check your occupation.
- Include ZIP code—requests may not be filled without it.
- Tear out lower half of this insert and place in mailbox.

Note the deadline date—Requests received after this cannot be filled.

▼ Free catalogs & literature

Subscribe or renew your present subscription to the nation's favorite electronic servicing magazine . . . ELECTRONIC SERVICING (formerly PF REPORTER).

Now with expanded editorial coverage of the entire electronic servicing business, ELECTRONIC SERVICING is more valuable to you than ever! Monthly it brings you the latest solutions to service problems on home entertainment electronics, including concise, timely coverage of new testing methods, product reports and practical service procedures!

Start ELECTRONIC SERVICING coming by sending in this order form . . . TODAY!

▼ Subscription offer

APRIL, 1976  
OFFER EXPIRES JULY 1, 1976

Please indicate number of items you have circled →

1 2 3 4 5 6 7 8 9 10 11 12 13 14 15 16 17 18  
19 20 21 22 23 24 25 26 27 28 29 30 31 32 33 34 35 36  
37 38 39 40 41 42 43 44 45 46 47 48 49 50 51 52 53 54  
55 56 57 58 59 60 61 62 63 64 65 66 67 68 69 70 71 72  
73 74 75 76 77 78 79 80 81 82 83 84 85 86 87 88 89 90  
91 92 93 94 95 96 97 98 99 100 101 102 103 104 105 106 107 108  
109 110 111 112 113 114 115 116 117 118 119 120 121 122 123 124 125 126  
127 128 129 130 131 132 133 134 135 136 137 138 139 140 141 142 143 144  
145 146 147 148 149 150 151 152 153 154 155 156 157 158 159 160 161 162  
163 164 165 166 167 168 169 170 171 172 173 174 175 176

Print plainly or type below:

Name

Firm

Firm Address

City  State  Zip

Did you receive this issue through  Distributor  Subscription

## Subscription Offer

Enter my subscription to ELECTRONIC SERVICING

3 Years \$13.00  2 Years \$10.00  1 Year \$6.00

Bill Me  Remittance Enclosed  Extend Present Subscription

**IMPORTANT!** Please check your business classification.

Type of Business

Position

Check One

Check One

- |   |  |
|---|--|
| A. <input type="checkbox"/> Independent Electronic Service Organization     | H. <input type="checkbox"/> Owner, Manager |
| B. <input type="checkbox"/> Retailer with Electronic Service Department.    | I. <input type="checkbox"/> Ser. Manager   |
| C. <input type="checkbox"/> Independent or Self-Employed Service Technician | J. <input type="checkbox"/> Technician     |
| D. <input type="checkbox"/> Electronics, Radio, TV Manufacturer             | K. <input type="checkbox"/> Other          |
| E. <input type="checkbox"/> Industrial Electronic Service                   |  |
| F. <input type="checkbox"/> Wholesale, Jobber, Distributor                  |  |
| G. <input type="checkbox"/> Other (Specify) .....                           |  |

Be sure you have checked one box in each column above!

# **WRITING TO Electronic Servicing?**

**Help us prevent delay**

**If your comment or question is about . . .**

## **YOUR SUBSCRIPTION**

Changes of address or any questions about your subscription should be sent to the address at right. Please advise us of a change of address at least 4-6 weeks in advance of your move, if possible.



**Evelyn Rogers, Circulation Manager**  
**ELECTRONIC SERVICING**  
1014 Wyandotte St.  
Kansas City, Mo. 64105

## **ANY OTHER SUBJECT**

If you have a comment or question about an article, condition in the industry, a service tip or problem, need a part or schematic, or would like to pass along information about an industry oriented event, etc., write to:



**Carl Babcoke, Managing Editor**  
**ELECTRONIC SERVICING**  
1014 Wyandotte St.  
Kansas City, Mo. 64105

PLACE  
FIRST CLASS  
POSTAGE  
HERE

# **Electronic Servicing**

**P.O. Box 2512**

**Clinton, Iowa 52732**



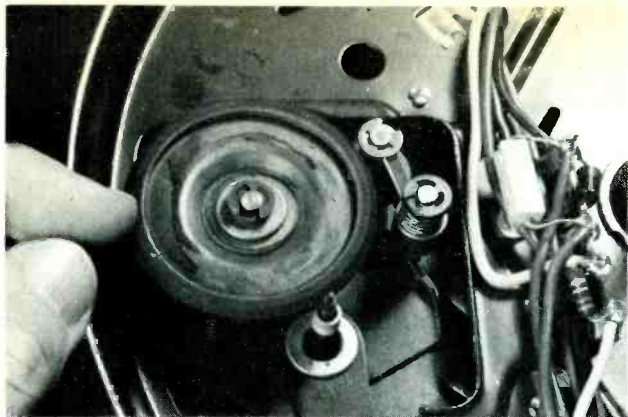

**Fig. 3** When the turntable is in playing position, the idler wheel touches the inside rim at the point indicated by the finger. A coil spring (in the shadow to the right of the thumb) pulls the idler assembly snugly into contact with both the rim of the turntable and the motor shaft, to drive the mechanism without slippage.

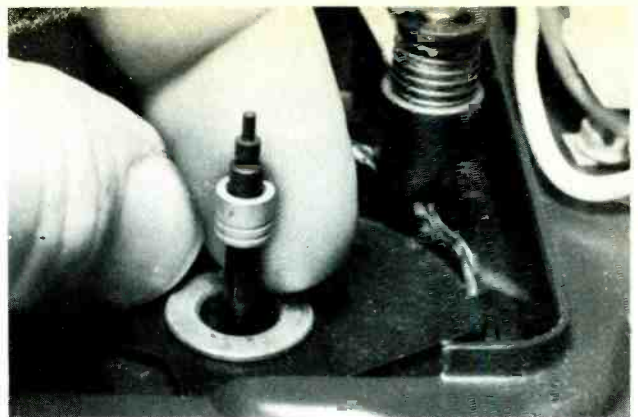

**Turntable speed** is changed by moving the idler assembly up or down (by means of the steps at the right of the forefinger) so the rubber tire rides against the motor-shaft drive bushing at the diameter that gives the desired speed. This drive bushing has 4 steps, for 16 RPM, 33 RPM, 45 RPM, and 78 RPM. Some newer machines have only 33 and 45 speeds.

Without grounding yourself, lift the tone arm high, and use the blade of a small screwdriver to touch each contact in turn. Hold the screwdriver by the blade, not the insulated handle. That way, strong AC hum picked up by your ungrounded body goes through the cartridge wiring to the amplifier, where it should produce a loud buzzing sound (if the gain is turned high).

Monaural cartridges usually have just two contacts, while stereo ones have three or four. A few cartridges have an extra ground. Regardless of the number of connections, a monaural cartridge should buzz only when one contact is touched, and a stereo cartridge should have two terminals producing a buzz.

Portable record players almost invariably have ceramic-type cartridges, and these can go bad, but seldom do they short. Therefore, if all "hot" terminals produce a proper amount of buzz, but one stereo channel is weak, dead, or distorted when playing a record, this is proof of a defective cartridge (the amplifier is okay).

On the other hand, a loud buzz at one terminal of a stereo cartridge, and weak buzz or no sound from the other is near-positive proof of a defective channel in the amplifier. One of few exceptions is a shorted or open cable between the cartridge and the amplifier.

One of the usual tips for solid-state audio is that the "buzz" tests

of gain don't give a very loud buzz, compared to the same test with tubes. However, the buzz test works fine with ceramic cartridges, because the cartridge is high impedance. Therefore, the input impedance of the amplifier **must** be high impedance, also, else the bass response will be decreased. It's the high impedance that makes the buzz test work efficiently, not transistors versus tubes.

### Minor Motor And Turntable Problems

Probably the number one complaint about record players is that the motor runs "slow", or stops during the change cycle (if it's a record changer). It's true that a few motors eventually do develop dry bearings, causing them to slow down or freeze, but usually the source of the problem is elsewhere.

In the mechanical path between motor and turntable, the point of least traction is between the motor shaft and the rubber-tired idler wheel (Figure 3). And the slippage problem becomes more severe at the slower turntable speeds, because the diameter of the drive bushing on the motor shaft is smaller, thus providing less surface area to contact the rubber tire.

When the turntable is in position, the point of contact between idler and motor shaft can't be seen at all from the top, and not very well from below the base plate. But if you can position the player where

you can watch the action of the drive system, the point of slippage is easy to prove. With the turntable running, use a thumb or finger to apply a slight pressure to the outside of the turntable rim. Then increase the pressure until the turntable stops, and notice which parts are turning and which are stopped. If the idler wheel is turning, the slippage is between it and the rim of the turntable. This can happen, although it's not too likely. Liquids containing abrasives are available for painting the inside of the turntable rim. However, roughing the metal with medium-grade sandpaper often works well.

### Slipping idler wheel

If both the turntable and idler wheel are stopped, but the motor shaft is turning (the usual condition with slippage), the problem is between the idler and the motor shaft. Most often, the rubber tire of the idler has become hard and perhaps glazed, which reduces the friction.

Another possibility is that oil or grease has gotten on the rubber tire, causing loss of friction. Where did the oil come from? It might have traveled from the idler bearing, when the player was turned on its side during transportation. But probably some misguided person over-oiled the motor bearings or the idler bearing. Too little oil definitely is better than too much around idlers.

Idler bearings occasionally need

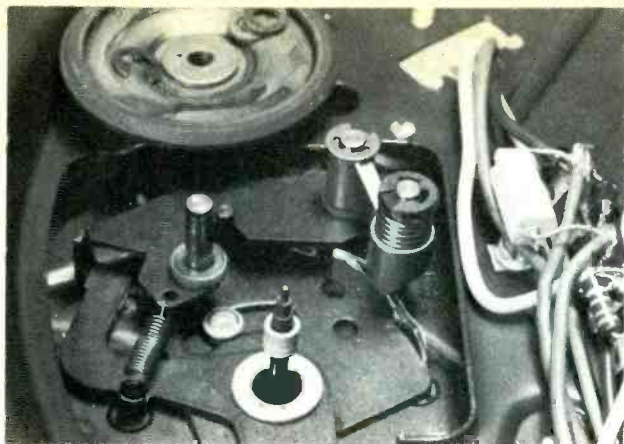

**Fig. 4** Slide the "C" washer sideways, and lift off the fiber spacer washers to remove the idler wheel. If a new idler wheel is available, install it. The rubber tire ages so that cleaning can't always restore it to satisfactory condition. Also, the pull spring (at the lower-left corner) might require replacement or shortening to increase the tension between the idler and the motor bushing. Most slippage originates between those two points.

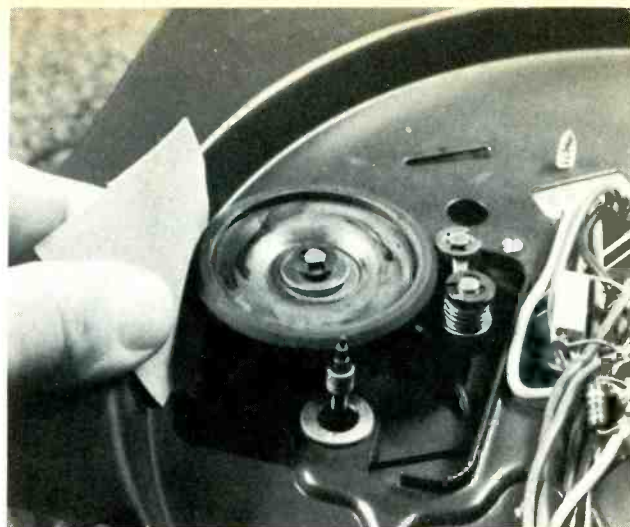

**With the motor** and idler running, hold a piece of medium-grade sandpaper flat against the rubber tire of the idler. If the rubber has not deteriorated too much, the roughing of the tire might restore the friction necessary for even and smooth speed.

oiling, but very little is required. To do it right, remove the "C" clip holding the idler in place (Figure 4), take off the idler, and remove all traces of oil from both male and female bearing surfaces and rubber tire (alcohol and a clean cloth are recommended). Apply **one** drop of oil to the idler shaft, spread it around a bit, and remove any excess. Reinstall the idler, being careful to not get any oil (perhaps from your fingers) on the rubber tire. (In fact, perspiration and skin oils from fingers can cause slipping idlers.)

Sometimes the glaze on a rubber tire can be removed by holding a piece of sandpaper against the rubber while the idler is being rotated by the motor. If this fails, the only permanent repair involves replacement of the idler wheel.

#### Weak motor?

Other technicians have told me a few times that a certain phono motor was "weak". Such a defect is almost impossible. Any motor with full rated voltage applied to it (no excessive resistances in series at switches or connections) **must** supply its rated power.

However, it is possible for this power to be dissipated in non-useful loads, leaving too little to rotate the turntable. Dry bearings, or bearings that are out of line, are two examples.

Testing for these possibilities is not difficult. Remove the turntable to expose the top of the motor, hold back the idler assembly so it doesn't touch the motor shaft, and switch on the power to the motor. Notice the time required for the motor to reach full speed, let it run for a few seconds, then turn off the power, and count the number of seconds before the rotation stops. A normal motor will run for several seconds, perhaps 5 or 10, but one with excessive bearing friction usually comes to rest within a second or two. Now, try to move the motor shaft sideways in every direction. One that allows very much movement probably has worn bearings, which might bind when the turntable is in place and the spring applies pressure sideways.

Dry motor bearings **can** be oiled, but, don't attempt this, if a replacement motor is available at a reasonable price. Oiling done quickly is not likely to be permanent, and it might release excess oil to foul up the idler later. Correct oiling is time-consuming, for it involves disassembly of the rotor and both bearings, thorough cleaning of old oil, saturating the oil reservoirs, adding a **tiny** bit of oil to each bearing, and reassembly.

One other source of slow turntable speeds, or lack of proper power should be considered: the ball-bearing assembly that supports

the turntable (Figure 5). The ball bearings originally were lubricated with "non-hardening" grease. But over the years, the grease **does** harden, sometimes locking the ball bearings. The assembly should be removed, soaked in alcohol to remove all old grease, and re-greased before it is replaced on the center spindle. Make sure the ball-bearing assembly has one flat washer (or more) above and below it.

#### Hum, Wow, And Flutter

Problems of speed and vibration can cause many kinds of unpleasant sounds to be mixed with the music from phonographs. Part of the solution is to identify them by definition.

#### Hum

Hum can be produced in two basic ways. One is vibration from the motor. Of course, the motor of all portable phonos (except the battery-operated ones) are powered from the 60-Hz line, and most hum has the same frequency. A motor with an unbalanced rotor can produce a hum that is heard only when a record is playing. It seems the motor vibration shakes the entire player baseplate, except for the end of the tone arm with the stylus and cartridge. Therefore, the effect is the same as though the stylus was moved at the hum



frequency.

One practical method of proving that the hum is from motor vibration is to feel the baseplate while the motor is running. Again, you'll have to test a few normal ones to arrive at a standard. If the vibration seems to be excessive, allow the motor to run while you rest the stylus on a piece of solid material (wood or plastic) on the baseplate at the side of the turntable. A definite hum heard through the amplifier, and no hum

with the arm held loosely in your fingers above the baseplate, is good proof that the hum is caused by motor vibration. In most cases, the only sure cure is to replace the motor with a better one.

Hum heard with the arm on its rest, but not with the cartridge wires disconnected from the input of the amplifier, indicates poor shielding of the cable from cartridge to amplifier. Of course, a hum louder than the music is near-proof of an open of the ground wire of

the cartridge. All portable machines have some hum, but it should not be loud enough to interfere with the music.

Portable phonos have another hum problem that's almost confined to the breed. Virtually all of the ones using tubes have a "hot" chassis design without a power transformer. Check the amplifier visually and examine the schematic for an isolated source of AC. If the power supply is safely isolated, the motor frame and record player

## TWO-TONE GENERATOR FOR SSB TRANSCEIVERS

MODEL ELTONE 76



**ELTONE 76 + GN 1375B =**

**A PERFECT  
MATCH FOR  
AM/SSB  
CB RADIOS**

- 100% solid state.
- Generates single or dual tones.
- Solid-state "light emitting diodes" are used to tell "at a glance" which tone is "on."
- Balance control with electronic indicator for equalization amplitude of tone "A" and tone "B"
- Level control
- Variable frequency for tone "A" and tone "B"
- Up to 3V. RMS output into 600 Ohms
- 1% maximum distortion
- The combined output of the two-tones are directly coupled to an emitter-follower stage
- Low output impedance also permits direct driving a carbon microphone audio input for radio telephone system.
- Regulated power supply.

**DEALER NET \$245.00**

**UPDATED CRYSTAL CONTROLLED CB & COMMUNICATION ANALYZER MOD. GN-1375B** with laboratory accuracy. **DEALER NET \$595** includes rechargeable batteries and all accessories. Custom made for quality and dependability. **5 YEAR GUARANTEE** on modules and crystals.

### Applications: X-TAL CONTROLLED RF GEN.

- For fast, professional servicing and testing on all makes of CB transceivers and other communication products.
- For testing unknown X-tals and X-tals activity from 3.5 MHz to 160 Mhz.
- Alignment and calibration.
- Testing of mobile and base stations.
- Measurement of sensitivity (signal-to-noise ration).

- Functions as modulated low pwr. transmitter or frequency references for system checkout.

### "TRANSTESTER"

- Measurement of true RF pwr. output to 50 W.
- Measurement of modulation percentage.
- Measurement of SWR (fwd. & ref.)
- Monitoring relative field strength.
- Direct reading.
- 50 Ohms noninductive built in dummy load 50 W cont.

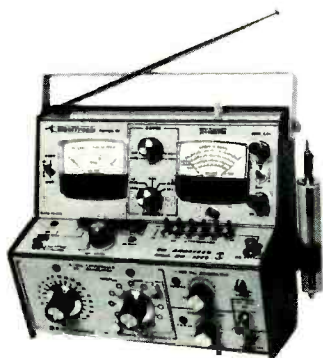

**MOD. GN-1375B**

**DEALER NET \$595**

### Features:

- RF generator has 23 X-tal controlled CB frequencies, as authorized by FCC • Each channel has individual crystal with tol. + 0.002% • 72 reserve channels from 3.5 MHz to 160 MHz or Civil Air Patrol (C.A.P.), Radio control channels A, B, C, D and E, Special business band channels 22A, 22B, 24, and 25 *Optional*. • 455kHz IF signal • 400 Hz audio signal • AC/battery operated for more flexibility • Two X-tal sockets are available for external X-tals • Calibrated RF output into 50 Ohms • Double RF shielding and aluminum cast RF attenuator • All circuitry are built in 5 epoxy glass P.C. modules shielded and sealed for dust and rain proof. • RF/AF Signal tracer with probe • Regulated power supply-charger with rechargeable Ni. Ca. batteries • BNC output connector for frequency counter for testing unknown X-tals and all RF frequency sources from GN-1375B • RF wattmeter 0-10 and 0-50 W • Dummy Load 50 Ohms/50W • SWR meter • RFS (relative field strength monitor) • % modulation.

### UPDATED FEATURES FOR "TRANSTESTER"

- **DETECTOR OUTPUT:** New features fill the need for frequency measurements and modulation display on the scope without physical connections between CB transceiver and the Mod. GN-1375B.
- **XMT.** output connector for frequency measurements and aurally checked modulation with built-in signal tracer.

### UPDATED FEATURES FOR X-TAL CONTROLLED RF GEN.

- Input for Ext. Mod. or two-tone generator Mod. Eltone 76.

**NikoTronix**

2437 W. Peterson Avenue • Chicago, Illinois 60659  
Telephone (312) 275-4727

For More Details Circle (14) on Reply Card

baseplate both should be grounded (through a separate wire from the cartridge ground) to the chassis, or other common ground.

Some specific models obtain amplifier AC voltage from a separate extra winding of the motor. If there is no continuity to the 120-volt winding, this counts as an isolated power source.

Any models **without** isolation between AC and the amplifier power supply will have one of two possible problems: either **hum caused by poor grounding between baseplate and amplifier ground** (usually through a small capacitor or RC filter); or the **entire metal portion of the record changer is a shock hazard** (bypassed through a large-size capacitor, or worst of all, directly connected to one side of the AC line).

Point is: the manufacturers have designed all these machines with baseplate grounds sufficient to keep hum fairly low, and with enough AC isolation to prevent more than a tingle if a person operates the phono while standing on a damp concrete floor. **Don't ever defeat this safety design by changing the wiring, or increasing the size of any isolation capacitors.**

#### Wow

Most customers describe "wow" as the motor running slow, but that's wrong. Turntable speed that is fast or slow, but steady, merely changes the pitch of the music (changes it to another musical "key"). No, the problem is **varying speed**.

Human ears are better at hearing pitch changes from wow than are many measuring methods. My favorite method is to play a record containing a passage with **piano** music, preferably slow chords. If the music goes "uhh-wow-uhh-wow" on all long, slow notes, that is wow.

Wow occurring just once per revolution of the turntable usually originates with the turntable or the idler wheel. For example, the center bearing of the turntable, or the ball-bearing assembly below the turntable, gummed up with old oil can cause slow wow. In a few rare cases, the trip pawl was touching

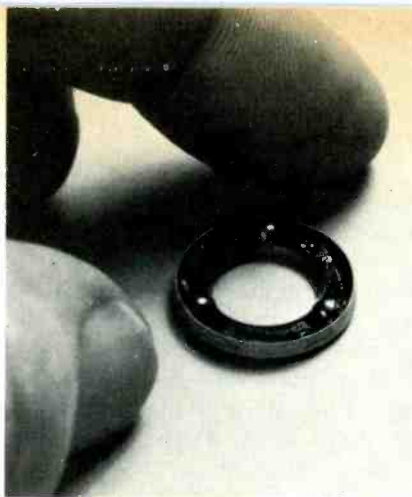

Fig. 5 A ball-bearing assembly is used between the turntable and the mounting. These balls can bind or become hard to move, because the grease has hardened. Such defects can slow the turntable speed, or cause wow.

the protrusion on the base of the turntable, and slowing down the speed once each revolution.

Faster wow (and sometimes flutter) is most often caused by a defective idler wheel. Either it slips more against the motor shaft at some places on the rubber tire, or there might be dents or grooves in the rubber tire. Dents can be caused by a mechanism that does not relieve the pressure between motor shaft and idler when the machine is turned off. Sometimes it's the fault of the customer who unplugs the machine from the wall rather than using the "off" control on the machine (which in some machines, pulls the idler assembly back).

Grooves in the rubber tire are caused by operation of the motor when the turntable is stalled. Rotation of the motor shaft against the rubber tire eventually can grind away the material. Operate the machine as you lightly rest your finger tips on the base plate; several regular-spaced bumps per second prove the idler is bad.

#### Flutter

Fast variations of either frequency or amplitude of the music are called "flutter". Nearly all cases originate with the idler wheel, or near there in the power train. However, a defective cartridge sometimes will be affected by the **normal** vibration of flutter. In such problems, a small extra weight on top of the cartridge will eliminate

the flutter temporarily, serving as a test.

#### Rumble

With portable record players, rumble seldom becomes bad enough to be noticed. That's because "rumble" is a low-frequency noise, sounding much like thunder. It's caused by unwanted movement of the turntable, usually an up-and-down motion.

Most rumble is produced by whatever holds up the turntable. In expensive machines, a single, large ball-bearing fits against a dent in the bottom of the turntable shaft. Record changers each have a ball-bearing assembly, previously described, between a flat surface on the bottom of the turntable and a part of the base plate. Any bumps or irregularities of these surfaces move the entire turntable up or down, thus moving the stylus. Turntable inertia prevents fast movements, so the sound is very-low in frequency.

The speaker systems of portable phonos seldom have enough bass response to reproduce rumble directly. But severe rumble can amplitude modulate the music, causing the sound to quiver. This is a form of intermodulation distortion.

#### Microphonics

Both console and portable stereo systems are susceptible to microphonics. Usually this is heard as a howl (sustained audio tone) mixed with the music, when the volume is turned up loud. Basically, **it's produced by vibrations of the speaker** (or cabinet vibrations from the speaker) **that reach the pickup cartridge**.

The possibility of microphonics is the reason the manufacturers spend extra money to mount all record changers on springs, or rubber mounts. These mechanical decouplers act as filters to minimize cabinet vibrations reaching the baseplate of the changer. Such filters are more effective at high frequencies, that's why the hard-to-solve problems have bass-frequency howls.

Even portable phonos with record changers need to have the shipping



screws loosened to minimize microphonic howls. Console stereos need it even more. Test by advancing all tone controls to maximum, and, with a record playing, turn up the gain to determine if a howl develops. A more sensitive test is to rest the stylus on a block of wood at the side of the turntable. Few machines can tolerate full gain without howls during this test. If the howls bother at any volume the customer wants to use, you must work on the changer mounting.

For example, the screws must be more-than-barely loosened. They should not touch the mounting

springs at all. I have found a few with off-center screws that required removal of the shipping screws to quiet the howls. Of course, this is not recommended for portables.

Modular units with separate changer and speaker locations can have severe problems because of the better bass response. Sometimes it's necessary to mount either changer or speaker on rubber pads.

### Comments

Not all phonograph repairs require a technician to have perfect knowledge of how a record changer operates. Also, it's certainly futile

and costly for him to remove an internal amplifier for testing, and then learn that the problem was in the cartridge or stylus. That's the idea behind these suggestions.

We chose these phonographs as typical of the breed, and the kinds most likely to be encountered, even though we know there are exceptions. Many of the methods apply equally well to console or modular stereo machines that have a record changer.

Next month, the subject will be the theory and practical troubleshooting of simple audio amplifiers. □

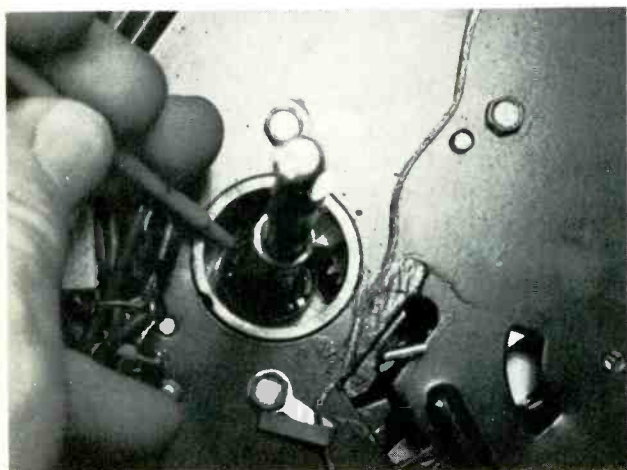

The ball-bearing assembly should be installed on the center-post shaft before the turntable. There normally are one or two flat washers below and above the bearing. The number of washers determines the height of the turntable; too few cause the turntable to scrape on the baseplate.

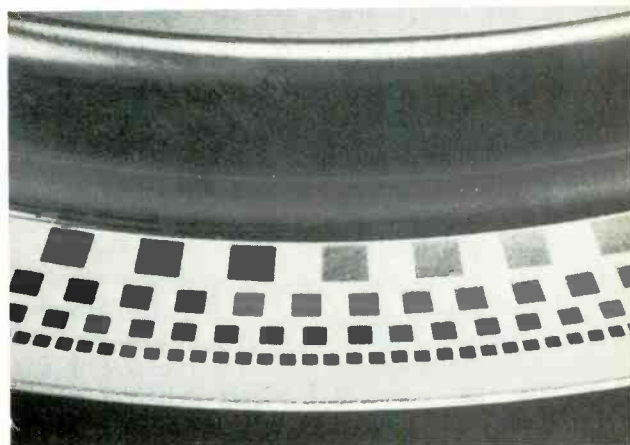

Stroboscopic patterns viewed under a 60-Hz light source (fluorescent or neon are best) can show average turntable speed. The proper circle of lines seem to stand motionless when the speed is correct. However, a listening test often is more accurate in identifying variable speed (wow). This pattern is on the underside of the turntable, where it can be viewed through a system of mirrors, while the speed control is varied.

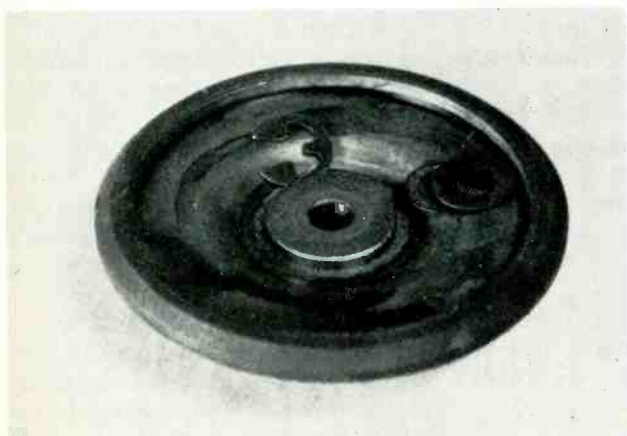

Examine the tire of the idler for dents or vertical grooves that can cause flutter or wow. Replace the idler wheel, if there is any doubt about the condition.

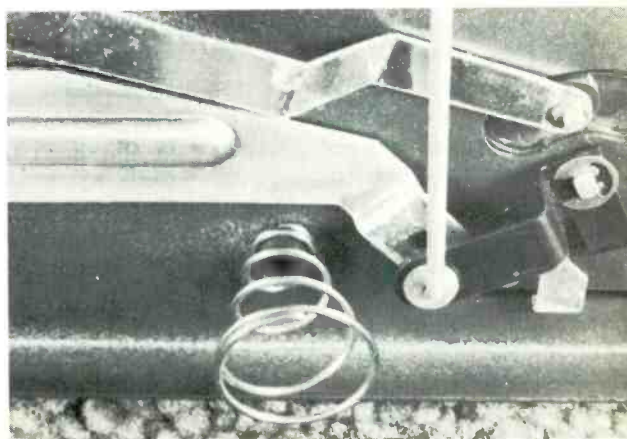

Floating the record changer on three or four springs, such as this one, helps minimize any microphonic howl.

# Reports from the test lab

By Carl Babcoke

*Each report about an item of electronic test equipment is based on examination and operation of the device in the ELECTRONIC SERVICING laboratory. Personal observations about the performance, and details of new and useful features are spotlighted, along with tips about using the equipment for best results.*

## "Volksmeter" Digital Multimeter

Model LM-3 digital multimeter from Non-Linear Systems has several unique and useful features, including:

- operation on internal NiCad batteries, with a jack for an external charger unit;
- small size and weight (1.9"H X 2.7"W X 4.0"D, and 9.2 ounces);
- 3 full digits using a 0.33" LED display;
- automatic zeroing of all functions;
- automatic polarity of DC functions;
- 4 high-accuracy DC and AC voltage ranges, 5 kilohm resistance ranges, and provision for external shunts for DC and AC current ranges; and
- 10-megohm input resistance for voltage ranges.

However, you could have learned all that information from an advertisement. To supplement it, I'll give the results of our lab tests, and my impressions of this tiny meter obtained over a period of several months during actual repairs of stereo machines and color TV's.

Size of the meter probably was the first thing I noticed. It's a comfortable handful (see Figure 1), that's only slightly too large to fit in a shirt pocket. But the performance seems comparable to meters of much larger size.

The smallness brings another practical advantage: wearing the meter while you work. Several options are possible with the leather carrying case (extra cost, but worth it). The case has a top fastened with snaps, for transportation. The top can be removed and a shoulder strap installed. This is very handy. Room is provided in the case for

the test leads; that way the meter is ready for use any time. The large LED readout permits readings from 9 or 10 feet away, so looking down on the meter at the end of the strap presented no problems. Of course, the small size and weight allow moving the meter and case to any other temporary location, when desired.

I liked the next method of operation even better. On the back of the case is a belt loop with metal snaps (Figure 2). With the case fastened to my belt, the meter was quite steady (not swinging from body movements), and the knobs could be turned or the readings observed easily. The external battery charger shows in the background of the picture.

## General Features

Many differences of operation have been noticed between various models of digital multimeters, even ones having similar outward appearances.

Overranging is one example. Some 3-1/2 digit models have a 1-volt range, that reads up to 1.999 by using the half-digit to supply the 1. Another might have a 2-volt range, reading up to 1.999 before giving the overrange signal. Because the Model LM-3 has 3 digits, it reads to .999 volt on the 1-volt range, then overranges above that, showing a blinking 1 and three steady zeros (1.000). The same readout is seen when the instrument overranges on any other scale or function (resistances, as an example).

## Resistance Readings

Resistance readings are all in thousands of ohms (K ohms),

except the top megohm range. In other words, if you select the 10 range, it means the maximum possible reading without over-ranging is one less digit than 10K, or 9,990 ohms which appears as 9.99 on the readout. In the same way, the megohm range reads to 9.99 megohms without overranging.

Rotation of the range control moves the decimal to the proper position, which is the same for all AC voltage, DC voltage, and resistance functions.

## DC Voltages

Factory specs call for an accuracy of DC-voltage readings of  $\pm(0.1\%$  of full scale plus 1% of reading) at 10 megohms input resistance. In other words, the accuracy is about  $\pm 1.1\%$  at full scale. When checked against other digital meters, the readings of the LM-3 were very similar. No drifting was noticed.

Either a plus or a minus sign is displayed automatically for DC voltages.

## AC Voltages

The same specs apply generally for AC-voltage readings, except no polarity sign is lighted.

All AC calibrations are RMS, and there is no formula for changing this to peak-to-peak. The frequency response was not perfectly flat, but it rolled off at the high end of the audio range. At 7 KHz, the response was about -1 dB, and it was down about 2-1/2 dB at 16 KHz. An unexplained peak appeared at 3.3 MHz. Most digital meters are not recommended for AC video measurements, and that's the case here, also.

## Current Measurements

TV and electronic technicians seldom measure current; therefore, the omission of such readings in the LM-3 brings no hardship. Leaving out current measurements certainly simplifies the meter, and eliminates an extra jack for the test leads.



Also, Non-Linear Systems has made provision for the few who desire DC/AC current readings. They offer a choice of five external shunts giving maximum current measurements of 100 microampere, 1 milliampere, 10 milliamperes, 100 milliamperes, and 1 ampere. Any of these is plugged into the two input jacks, then the test leads plug into the shunt. The method is simple, but effective.

### Comments

Perhaps we tend to equate smallness with weakness. At least, I found myself babying the LM-3, at first. The tiny knobs and overall size, even the blue-green color of the plastic case, gave the impression that it was a toy.

But that false impression evaporated when I snapped off the back panel, and slid the works out of the plastic case (Figure 3). Inside, the meter is built very ruggedly, in about four layers, with connecting braces soldered, making a solid assembly. Boards appear to be a sturdy glass type.

The factory specs say the meter can be dropped several feet without loss of calibration accuracy. While I had the works out of the case, I tried (with some misgivings) to bend or break the plastic with my fingers. I suppose breakage might be possible, but the case certainly is tougher than it appears.

One time, a test lead became loose in the panel. It was not the jack (they are strong and soldered to a heavy board); but the spring parts of the banana test prod had been bent.

Operation of the Non-Linear Systems Model LM-3 was excellent, with a minimum of "bobble" (changing of the last digit), and a maximum of convenience. By using moderate care in turning off the power when not making a reading, I never allowed the battery to run down. An occasional charging kept the meter in full operation. □

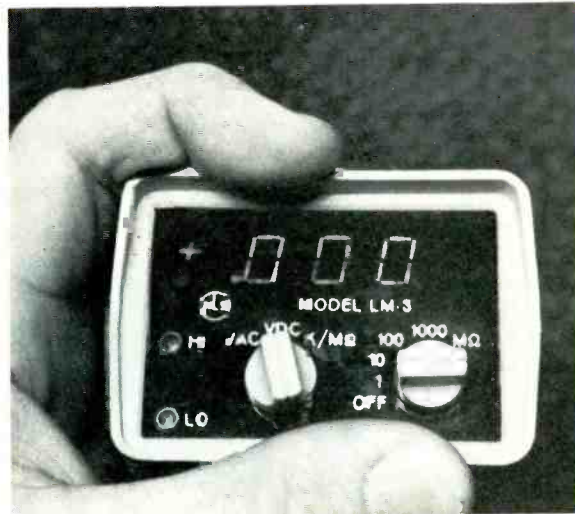

Fig. 1 Small size of the Model LM-3 Non-Linear Systems digital multimeter allows hand-held operation, or operation in a leather case with a shoulder strap. The readout is large relative to the meter size.

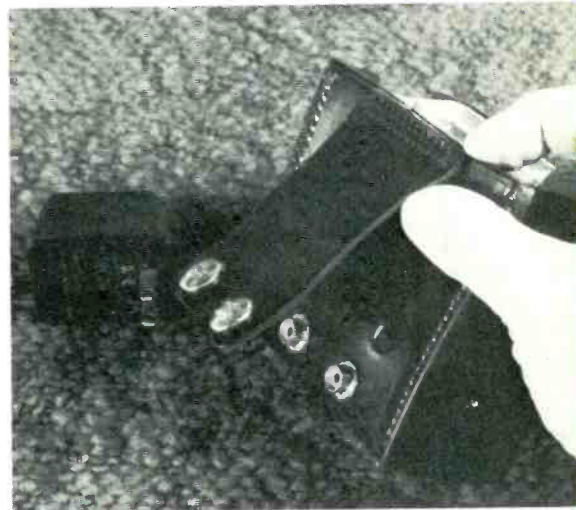

Fig. 2 A flap with snaps on the back of the leather case clips around a man's belt, giving convenient operation, and leaving both hands free.

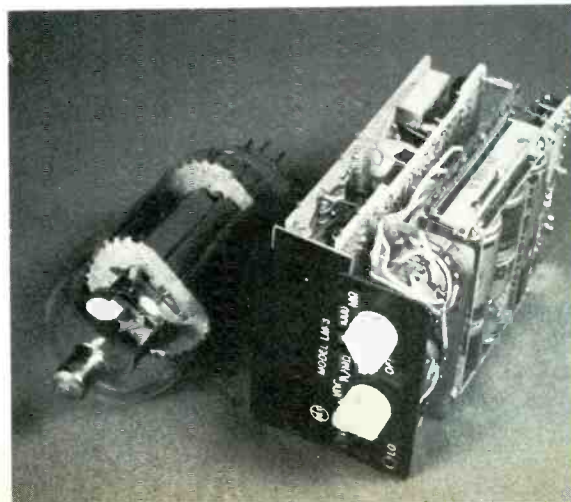

Fig. 3 The LM-3 is only slightly larger than a 6JE6 tube, yet it has 9 IC's, several transistors, three batteries, and many components. All of the boards are fastened together, making a solid and strong assembly.

# audio systems report

These features supplied by the manufacturers are listed at no-charge to them as a service to our readers. If you want factory bulletins, circle the corresponding number on the Reply Card and mail it to us.

## Audio Products

A new line of 13 audio-accessory products has been introduced by **Tech Spray**, and is marketed under the name of "Kleer Tone".

Three new products in the Kleer Tone line are: **Speaker Cone Renew**, designed to rejuvenate stiff, dry speaker cones; **Wood Oil Treatment**, to prevent oiled wood cabinets from splitting; and **Record Shampoo**, to be mixed with water to remove dirt, dust, and oily fingerprints from records.

Tape Head Cleaner in aerosol and bottle, Tape Head Lube, Cleaning Sticks and Cloths, Record Cleaner, Speaker Cement, and Contact Aerosol Spray cleaner complete the line.

For More Details Circle (30) on Reply Card

## Weatherproof Speaker

The Speco Model 0-83 from **Component Specialties** is a heavy-duty 8" speaker of 8-ohms impedance for outdoor music reproduction, such as on patios. It has an all-metal baked-enamel finish, and is unaffected by humidity, rain, snow, or sleet.



Model 0-83 comes with level control and a 20-foot cable. Cabinet size is 10½" X 11" X 5¼", tapering to 4". Power rating is 10 watts "music power".

Model 0-83 lists for \$27.20.

For More Details Circle (31) on Reply Card

## "Off-The-Wall" Sound Idea

**Magitran Company** has developed a limited-space speaker designed for mounting in vans and compact cars, as well as other restricted spaces. The 1½"-deep speaker mounts on the wall with four screws; no cutting of the mounting surface is required.

It covers a range of 90 to 20,000

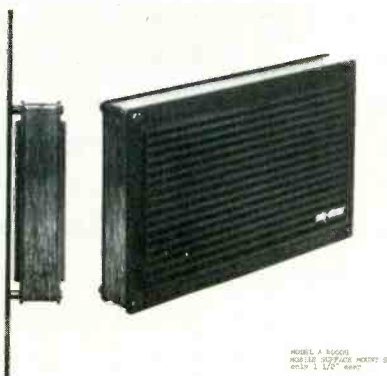

Mike specifications are: sensitivity: -40 dB; frequency response: 300 to 500 Hz; impedance: 600 ohms; amplifier voltage gain: 0-15 dB; temperature range: -20°C. to +60°C. It uses a standard 9-volt battery, and comes equipped with a 6' shielded coiled cord.

For More Details Circle (33) on Reply Card

## Mobile Extension Speaker

A new mobile extension speaker from **Kris** is designed for voice-range audio reproduction.

Model 417-500 features a 3½" speaker for 3 watts of power. It comes in a molded ABS plastic case, with a gimbal mounting bracket, and has a molded cable with 3.5-mm phone plug. Dimensions are 4¾" X 4" X 3". Suggested price of the Model 417-500 is \$12.95.

For More Details Circle (34) on Reply Card

Hz, works with any 4-8 ohm source, and handles a full 10 watts RMS of power.

Speakers are packaged in pairs for stereo and come complete with mounting hardware and 12 feet of audio cable. Suggested price is \$29.95 a pair.

For More Details Circle (32) on Reply Card

## Power Base Mike

The Power Base Mike from **GC Electronics** has a built-in two-stage

## Solution to: SHERLOCK OHMS AND....

- |             |  |              |             |
|-------------|--|--------------|-------------|
| 1 amperage  | 2 Bakelite                                 | 3 standard   | 4 wrinkled  |
| 5 wireless  | 6 vertical                                 | 7 vitreous   | 8 bistable  |
| 9 assemble  | 10 tweeters                                | 11 angstrom* | 12 tungsten |
| 13 obsolete | 14 Meissner                                | 15 autodyne  | 16 foldover |
| 17 blooming | 18 manganin                                | 19 unfasten  | 20 abampere |
| 21 wrapping | 22 galvanic                                | 23 Phillips  | 24 multiple |
| 25 flutter  | (A. J. Angstrom Swedish physicist 1814-74) |              |             |

Start with 100 points and deduct 4 points for any part you may not have answered correctly.

## Your rating:

- |                               |         |         |       |
|-------------------------------|---------|---------|-------|
| 60-64                         | 68-72   | 76-84   | 88-96 |
| Skilled.                      | Expert. | Master. | Whiz. |
| 100 PERFECT! You're a genius! |         |         |       |

## FREE CATALOG

### HARD-TO-FIND PRECISION TOOLS

Lists more than 2800 items: pliers, tweezers, wire strippers, vacuum systems, relay tools, optical equipment, tool kits and cases. Also includes ten pages of useful "Tool Tips" to aid in tool selection.

**JENSEN TOOLS**  
4117 N. 44th Street, Phoenix, Ariz. 85018



For More Details Circle (15) on Reply Card



# test equipment report

These features supplied by the manufacturers are listed at no-charge to them as a service to our readers. If you want factory bulletins, circle the corresponding number on the Reply Card and mail it to us.

## Portable Semiconductor Tester

A battery-operated automatic semiconductor tester is being introduced by **B&K-Precision**. Model 510 features a HI/LO power drive and permits rapid in and out-of-circuit testing of bipolar transistors, FET's, SCR's, and monolithic and hybrid Darlington's.

The LO power drive provides a positive GOOD/BAD indication plus automatic identification of base, collector, and emitter leads. The HI power drive position is used to test semiconductors in circuits with shunt resistances as low as 10 ohms and shunt capacitances as high as 25 microfarads.

According to the manufacturer, a complete transistor test can be made in nine seconds or less. LED indicators are used to signal NPN-OK or PNP-OK, and the leads are identified by the color-coded position of the test

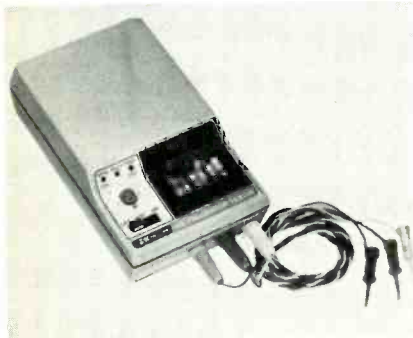

switch. Out-of-circuit tests also can be made rapidly using the Mini-Lock test clips or the built-in test socket. A flashing LED indicator on the panel serves as a reminder to turn the unit off when not in use.

Model 510 comes complete with three color-coded Mini-Lock test clips and carrying case; the price is \$90.

For More Details Circle (35) on Reply Card

## Digital VOM

Model 360 "Series 2" digital volt-ohm-milliammeter from **Simpson Electric** is an all-purpose portable 3-1/2 digit instrument designed for both field and bench use.

It operates on either AC power or rechargeable batteries; 29 ranges

measure AC volts RMS, DC volts, AC and DC current and resistance, with automatic polarity and flashing over-range indication. All ranges are overload protected.

Two "low-power" ohms ranges (200 mV full-scale voltage) allow the user to make "in circuit" resistance measurements without "turning on" most semi-conductor junctions.

Measurements are displayed on 7-segment 0.43" LED readouts. A zero-center calibrated analog meter gives indications for nulling, peaking and scanning.



The 360 "Series 2" offers high accuracy; for example,  $\pm 0.25\%$  of reading +1 digit on DC voltage ranges.

For More Details Circle (36) on Reply Card

## Sweep/Marker Generator

Model LSW-333 all-channel sweep/marker generator for checking and aligning tuned circuits in TV and FM receivers is offered by **Leader Instruments**.

With a scope, the generator allows the sweep aligning of TV tuners,

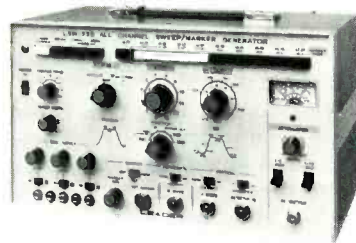

video IF's, traps, and chroma-band-pass stages, using multiple crystal-controlled post-injected markers. Any marker can be amplitude-modulated by a 1-KHz sine wave for the adjustment of TV traps. Both 100-KHz and

(Continued on page 50)

# Are you, of all people, still opening your garage

# the hard way?

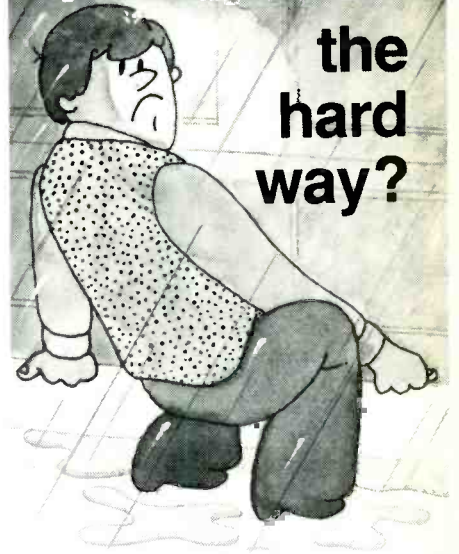

## Anybody who's into electronics

certainly should be getting the everyday convenience and family security of automatic garage door operation... especially now, with Perma Power's great Electro Lift opener...

made to fit in the trunk of your car, designed for easy handling and simple do-it-yourself installation. Available now at a surprisingly low price from your distributor.



**P.S.** Show off your opener to your friends and neighbors. You'll probably be able to pay for yours with what you make installing openers for them.

## Perma Power Electro Lift®

PRODUCTS OF **Chamberlain**  
Chamberlain Manufacturing Corporation  
Perma Power Division  
5740 North Tripp Avenue  
Chicago, Illinois 60646

# COST EFFECTIVE COMPONENTS

**April Special**  
**IC ASSORTMENT**  
**25 COMMONLY USED**  
**IC FOR TV AND STEREO**  
**Assortment \$22.50**

## C.E.C.'s First Line Transistors

		Equivalents			
		ECG	RCA	GE	
CEC	TR01	162	SK3079	—	\$3.45
CEC	TR02	123	SK3122	61	.34
CEC	TR03	159	SK3114	67	.34
CEC	TR04	152	SK3041	14	.75
CEC	TR05	241	—	—	1.30
CEC	TR06	197	SK3085	—	1.90

ICs	ECG	Equivalents		
		RCA	GE	
CEC	IC01	714	SK3075	IC04 5 for \$4.50
CEC	IC02	731	SK3173	— 5 for 4.50
CEC	IC03	713	SK3077	IC05 5 for 4.50
CEC	IC04	790	—	5 for 4.50
CEC	IC05	712	SK3072	IC02 5 for 4.50
CEC	IC06	709	SK3135	IC11 5 for 4.50
CEC	IC07	710	SK3102	— 5 for 4.50
CEC	IC08	725	SK3162	— 5 for 4.50
CEC	IC09	718	SK3159	IC08 5 for 4.50
CEC	IC10	720	SK3160	IC07 5 for 4.50
CEC	IC11	723	—	— 5 for 4.50
CEC	IC12	—	—	— 5 for 6.00

## C.E.C. Specials

160 MFD 250 VDC Filters 1"			10 for \$9.00
160 MFD 250 VDC Filters 1-3/8"			10 for 11.00
Japanese transistor kit 20 most popular			8.25
Miniature electrolytic kit 25 popular types			8.25
72 ohm to 300 ohm Matching Transformer			10 for 6.50
	Zenith numbers		
	221-52	5 for	4.50
	221-62	5 for	4.50
	221-65	5 for	4.50
	221-32	5 for	4.50
	221-79	5 for	4.50
	221-34	5 for	4.50
	221-42	5 for	4.50
	221-45	5 for	4.50
	221-46	5 for	4.50
	221-48	5 for	4.50
	221-51	5 for	4.50
	Delco numbers		
	DM-11	5 for	\$4.50
	DM-31	5 for	4.50
	DM-54	5 for	4.50

We also stock new and used ultrasonic cleaners.

Minimum order \$25.00.  
We pay shipping.

# C.E.C.

Cost Effective Components  
P.O. Box 1965, Burlingame, CA. 94010  
415/344-6383

For More Details Circle (17) on Reply Card

(Continued from page 49)

1-KHz markers are available for FM alignment.

For tuner alignment, all VHF/TV, UHF/TV, and FM channels are supplied. Other features include: polarity reversing switches for vertical and horizontal; 3 adjustable bias supplies;

an X5 switch for increased vertical gain; marker-size control; a 15750-Hz filter to remove horizontal ripple; and an output meter with calibrated attenuator.

Price of the Leader LSW-333 is \$649.95.

For More Details Circle (37) on Reply Card

## Bench Digital Multimeter



A 3-1/2 digit, 2000-count bench multimeter that measures AC and DC volts, ohms, and capacitance has been introduced by **Data Tech.**

Model 20 has four DC voltage ranges with 1 millivolt resolution and 0.1% accuracy; four AC voltage ranges with 0.5% accuracy, and four resistance ranges with 1 ohm resolution and 0.2% accuracy.

For capacitance, the four scales

handle readings between 1 picofarad and 1.999 microfarads. Readout is in nanofarads, which can be changed to picofarads by moving the decimal point three places to the right. For microfarads, move the decimal point three places to the left.

A snapout stand tilts the meter for better bench viewing. The price of Model 20 is \$179.

For More Details Circle (38) on Reply Card

## Auto-Ranging Digital Multimeter

The 3-1/2 digit, five function, fully autoranging digital multimeter Model 3476A from **Hewlett-Packard** sells for \$225. Voltages are measured from  $\pm 100$  microvolts to  $\pm 1000$  volts DC and from 300 microvolts to 700 volts RMS AC. Resistance is measured from 1 ohm to 11 megohms. Current can be measured from 100 microamperes to 1.1 ampere DC, and 300 microamperes to 1.1 ampere AC. Autozero, autopolarity and autoranging are built in.

Typical accuracy for DC voltage measurements is 0.5%. DC current accuracy is 1.0%. On AC voltage ranges, frequency is specified to 10 KHz, while AC current measurement

is to 5 KHz. Accuracy of resistance measurements on the three highest ranges is 0.6% and to 0.4% on the two lower ranges.

Input resistance on all voltage ranges is 10 megohms with input capacitance of less than 30 picofarads. The 3476A is protected to 1100 volts peak on all ranges. The two fuses are common types, and they can be quickly replaced without disassembling the instrument.

A range "hold" feature is included, allowing the instrument to be locked to any desired range. The LED readout gives all voltage readings in volts, all resistance readings in kilohms, and all current readings in amperes.

For More Details Circle (39) on Reply Card



# productreport

These features supplied by the manufacturers are listed at no-charge to them as a service to our readers. If you want factory bulletins, circle the corresponding number on the Reply Card and mail it to us.

## TRC-56 CB Radio

The TRC-56 CB two-way radio from **Realistic** features a telephone-type handset, which is said to virtually eliminate background noise.

A speaker/handset switch lets you listen through the handset, the built-in speaker, or both. When using the handset speaker, replacing the handset in the cradle automatically switches operation to the transceiver's built-in speaker. A push-to-talk switch is built into the handset.

The TRC-56 is equipped with all crystals for full 23-channel operation, has an automatic gain modulation circuit, and is rated at 4-watts maximum AM output. It also features a delta-tune switch to help pull in off-frequency stations, and a built-in automatic noise-limiter and noise-



blanker switch. An adjustable squelch control silences the receiver between calls; an S/RF power output meter indicates the strength of incoming signals while receiving, and monitors power output when transmitting.

The Realistic TRC-56 is priced at \$179.95.

For More Details Circle (40) on Reply Card

## CB Radio Book

A new 116-page book published by **Radio Shack** is a plain-talk guide to the equipment, rules, and benefits of CB two-way radio.

Entitled "All About CB Two-Way Radio", the book covers such areas as: how CB radio came about; the equipment you need for CB two-way radiocommunications; how to select and install your radio; and the rules and regulations for CB use.

The book is priced at \$1.25.

For More Details Circle (41) on Reply Card

## Soldering Iron Holster

**Wahl Clipper Corporation** has available a convenient belt carrier for use with its soldering irons and accessories.



Constructed of heavy-duty leather, the holster will hold any of the Iso-Tip soldering irons as well as all of the different tips. A snap closure secures the holster firmly to any belt up to 2-1/2" wide.

For More Details Circle (42) on Reply Card

## Closed Circuit Fence Protection

The P6 "Fence Guard" for cyclone and wiretype fence areas has been introduced by **Mountain West Alarm Supply**.

P6 is a field-tested alarm sensor for detecting attempted entry over or through a perimeter fence, operating by use of a vertical-motion detector. Motion generated by any attempt to climb or cut the fence creates a momentary open in a protective loop,



(Continued on page 52)



# AUTOMATIC STAPLE GUNS

## CUT WIRE & CABLE INSTALLATION COSTS

... without cutting into insulation!

**SAFE!** Grooved Guide positions wire for proper staple envelopment! Grooved Driving Blade stops staple at right depth of penetration to prevent cutting into wire or cable insulation!

**No. T-18—Fits wires up to 3/16" in diameter.**



**BELL, TELEPHONE, THERMOSTAT, INTERCOM, BURGLAR ALARM** and other low voltage wiring.

Uses T-18 staples with 3/16" round crown in 3/8" and 7/16" leg lengths.

**No. T-25—Fits wires up to 1/4" in diameter.**

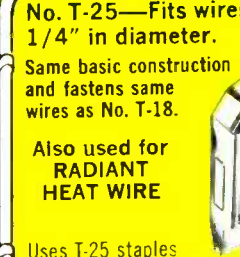

Same basic construction and fastens same wires as No. T-18.

Also used for **RADIANT HEAT WIRE**

Uses T-25 staples with 1/4" round crown in 9/32", 3/8", 7/16" and 9/16" leg lengths

**NEW! Intermediate No. T-37—Fits wires and cables up to 5/16" in diameter.**



Same basic construction as Nos. T-18 & T-25.

Also used for **CATV and DRIVE RINGS** in stringing wires.

Uses T-37 staples with 5/16" round crown in 3/8", 1/2" and 9/16" leg lengths.

**No. T-75—Fits wires and cables up to 1/2" in diameter.**

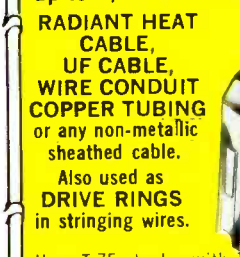

**RADIANT HEAT CABLE, UF CABLE, WIRE CONDUIT COPPER TUBING** or any non-metallic sheathed cable.

Also used as **DRIVE RINGS** in stringing wires.

Uses T-75 staples with 1/2" flat crown in 9/16", 5/8" and 7/8" leg lengths.



**ARROW FASTENER COMPANY, INC.**  
271 Mayhill Street, Saddle Brook, N. J. 07663

For More Details Circle (18) on Reply Card

**NEW**

**TeleMatic**

**SONY**

**PICTURE TUBE BRIGHTENER**



The option to replacing expensive Sony color picture tubes. (For most popular models.)

Another first from the pioneers in service test equipment.

**FOR MORE INFORMATION WRITE:**

**TeleMatic**

2862 Fulton Street  
Brooklyn, NY 11207

NAME \_\_\_\_\_

ADDRESS \_\_\_\_\_

CITY \_\_\_\_\_ STATE \_\_\_\_\_ ZIP \_\_\_\_\_

My supplier is: \_\_\_\_\_ AS

**SOLD THROUGH DISTRIBUTORS ONLY**

For More Details Circle (19) on Reply Card

(Continued from page 51)

thus operating an external alarm. Normal side motion, such as from wind or bumping does not affect the Fence Guard.

Each Fence Guard contains a tamper switch that triggers an alarm

if anyone attempts to remove the cover. Cutting cable that connects the sensors also operates alarm. Instructions are included for installation; and each P6 sells for \$20.

For More Details Circle (43) on Reply Card

**Motor Speed Control Kit**



A complete kit for constructing a solid-state motor-speed control is offered by GC Electronics' Calectro Division.

The Motor-Speed Control Kit, Catalog G2-104, can be used with electric hand drills and similar tools,

using an AC/DC or universal 115-volt motor requiring up to 500 watts (3/4 HP). The kit comes complete with an illustrated instruction booklet that contains helpful hints and construction techniques.

For More Details Circle (44) on Reply Card

**Lightning Arrestors For Coax Cable**

Ava Electronics has introduced a new line of lightning arrestors for the protection of CB radios using coax cable.

Model LA76 has both male and female connectors for installation between the CB radio and the coaxial cable from the antenna. A heavy-duty ground wire is run from the arrestor to a good ground on the body of a car or truck, or to a ground rod, if used in a home.

Both ends of Model LA076 are the female type for use outdoors, and the ground wire connects between a screw on the arrestor and a cold-water pipe or ground rod.

Model LA76 lists for \$3.95 each, and Model LA076 sells for \$3.50 retail.

For More Details Circle (45) on Reply Card

**FM Paging Receivers**

Three new FM "Pagemaster" selective pocket-sized paging receivers are available from the Bogen Division of Lear Siegler.

Models SS35VT (35 MHz), SS150VT (150 MHz), and SS450VT (450 MHz) are compatible with all existing EIA-standard two-tone-sequential FM systems. They operate by tone-signalling, as well as giving hands-free voice messages, and are suitable for use in both new and existing systems.

Features include a built-in memory which "stores" a page signal until the wearer is ready to receive it, active-filter decoding, and the ability to change codes in the field.

For More Details Circle (46) on Reply Card



# antenna systems report

These features supplied by the manufacturers are listed at no-charge to them as a service to our readers. If you want factory bulletins, circle the corresponding number on the Reply Card and mail it to us.

## CB Antennas

The "Thomas Jefferson Twins", dual gutter-mount 27-MHz CB antennas, have been introduced by the **Breaker Corporation**. The antennas are 28" high, and provide reinforced front-to-back signal gain. Each stainless steel whip has a static-arrester tip and a fine-tunable heavy-duty ABS encapsulated load coil.

Model 10-265 antennas come complete with an impedance-matched 18-foot co-phased coax cable termi-

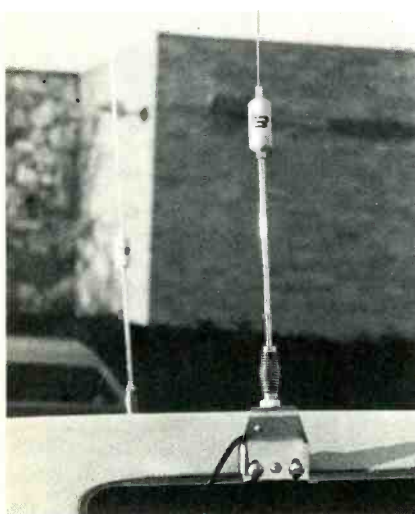

nated with a PL-259 plug for connection to any standard transceiver antenna receptacle. An Allen wrench for fine tuning the antenna also is included.

The "Thomas Jefferson Twins" have a suggested price of \$39.95.

For More Details Circle (47) on Reply Card

## Surface Mount Housing

A surface-mount housing for MATV (Master Antenna TV) tap-offs and feed-thru wall units has been developed by **Jerrold Electronics**.

The Model UTSH-2 housing accepts virtually any type of MATV tap-off, including Jerrold Ultra-Tap's, directional coupler taps, Omni-Tap's, and STO-75F self-terminating outlets. It can be mounted easily to any wall surface, accepting cables via break-away plastic sections and providing room for both input and output

cables. Once in place, the UTSH-2 can be used the same way as a standard gem box for concealed wiring.

Price of the UTSH-2 is \$1.00.

For More Details Circle (48) on Reply Card

## Mobile Radio Splitter

The **Hustler Monitor-Match Model LY-5** accepts the signals from outside-mounted or windshield auto antennas and has outputs for: AM/FM radio; 25-175 MHz radios; and 300-515 MHz radios. It is especially designed for operating single, dual, or all-band monitor radios, and comes complete with all cables and plugs. No installation is required.

Price of the Model LY-5 is \$8.95.

For More Details Circle (49) on Reply Card

## Coax Switch

The **Kris 418-502 Coax Switch** is an accessory needed by the operator using multiple antennas or multiple transceivers. The switch has three switched positions plus a 10-watt dummy load in the fourth position. All input and output connectors are located on the rear panel. It handles frequencies up to 50 MHz.

The Kris Coax Switch is housed in a anodized aluminum extrusion with a sloping front panel. Suggested price is \$12.95.

For More Details Circle (50) on Reply Card

## CharDon TV Antenna

The **O. W. Donald Company** has announced the development of a new CharDon TV antenna for recreational vehicles, such as campers, motor-homes, travel trailers, etc.

The "Tennarack" Model is a combination luggage rack and TV antenna. It is omnidirectional and never has to be raised or lowered. There are no elements to fold or bend.

The price of the "Tennarack" combination TV antenna/luggage rack is \$54.95.

For More Details Circle (51) on Reply Card

## Single-Channel Amplifiers

**Blonder-Tongue** has introduced high-output single-channel "strip" amplifiers for VHF use in MATV systems. Some specifications are: 7 volts of output with 64 dB gain; 7 dB noise figure, AGC range of 40 dB; bandwidth of 6 MHz  $\pm 0.5$  dB, with -26 dB at 9 MHz from center of channel; and modular construction for ease of servicing.

Model HMCA-B amplifiers are available for all VHF channels.

For More Details Circle (52) on Reply Card



## endeco soldering & desoldering equipment

**SOLDERING IRONS**



Pencil style. Safety light. Two heats — 20w and 40w. 6 tips. Unbreakable handle. 2 and 3 wire neoprene cords.

**DESOLDERING IRONS**



Pencil style. Safety light. Some operate at 40w, idle at 20w. 8 tip sizes. 2 and 3 wire neoprene cords.



**SOLDERING & DESOLDERING KITS**

Everything needed to solder or desolder or both. All in a handy lifetime metal box with hasp.

*See your distributor or write...*

**Enterprise Development Corp.**  
5127 E. 65th St. • Indianapolis IN 46220  
PHONE (317) 251-1231

For More Details Circle (20) on Reply Card

# need belts?



**Standard and special belts and tires** ready for immediate shipment — fit over 3,000 new and obsolete makes of tape recorders, projectors, dictating machines, video recorders, and turntables. Simplified cross reference system makes ordering easy with **one day service** on most items. Drive tires, wheels, phono idlers also listed. Call or write for **free catalog**. DEALER INQUIRIES INVITED.

**PROJECTOR-RECORDER BELT CORP.**  
319 Whitewater St., Whitewater, WI 53190 — (414) 473-2151

For More Details Circle (21) on Reply Card

# bookreview

## Troubleshooting With The Oscilloscope, Third Edition

**Author:** Robert G. Middleton  
**Publisher:** Howard W. Sams & Co., Inc., 4300 West 62nd Street, Indianapolis, Indiana 46268  
**Size:** 191 pages, book number 21103  
**Price:** \$5.50 paperback

This third edition was written to help technicians obtain maximum benefits from using a scope. Following a chapter about basic waveform analysis, the writer describes in detail every scope control and function. Although most of the coverage is concentrated on ways of troubleshooting television circuits, there are chapters covering power supplies, radios, and audio amplifiers. New material about testing stereo multiplex circuits is presented. Mr. Middleton suggests you actually perform many of the procedures as they are described.

**Contents:** Introduction; How to Operate an Oscilloscope; Using Oscilloscope Probe; Signal Tracing in RF, IF, and Video Amplifiers; Signal Tracing in the Sync Section; Troubleshooting the AFC and Horizontal Oscillator Section; Waveform Tests in the Horizontal-Sweep Section; Troubleshooting the Vertical-Sweep Section; Signal-Tracing the Sound IF and Audio Section; Troubleshooting Power Supplies; Radio-Receiver Troubleshooting; Testing Audio Amplifiers; Index.

## Practical CB Radio Troubleshooting and Repair

**Author:** David F. Norman  
**Publisher:** Tab Books, Blue Ridge Summit, Pennsylvania 17214  
**Size:** 237 pages, book number 754  
**Price:** \$8.95 Hardback copy

Most of the book gives practical answers for installation, repairs, and operation of CB transceivers. Theory and formulas are minimized. Author Norman supplies the information he believes is important, based on his extensive experience. The writing style is informal and conversational. Chapter 4 gives tips for setting up a CB service shop, including test equipment, suggestions for a bench with wiring, and a list of essential tools. Other topics are listed in the contents.

**Contents:** CB Beginnings; Operating Practice; Antennas and Feedlines; Equipment and Facilities for CB Service; Installation, Checkout, and Routine Maintenance; Introduction to Troubleshooting; Troubleshooting and Repair of Power Handling Circuits; Troubleshooting Low-Power RF and AF Circuits; Oscillator, Squelch, AGC and Miscellaneous Circuits; Appendixes; Index.

# photofact<sup>TM</sup>bulletin

<b>CURTIS MATHES</b> Chassis CMC-54 .....	1567-1
<b>GENERAL ELECTRIC</b> Chassis 19YC .....	1560-1
<b>HITACHI</b> T-11 .....	1571-1
<b>JC PENNEY</b> 685-2847, 855-2218, 2847 .....	1564-1
<b>MGA</b> CS-173 .....	1570-1
<b>PANASONIC</b> Chassis T506-A .....	1569-2
<b>PHILCO</b> Chassis 5CR41TS, 5CR41TSX .....	1564-2
<b>RCA</b> Chassis CTC74F/H/J .....	1568-1
<b>SEARS</b> 528.42002500, 528.42050500 .....	1570-2
<b>SONY</b> Chassis SMC-216A .....	1567-2
<b>TRUETONE</b> GEC4617A-67 (2DC4617) .....	1566-2
<b>WARDS AIRLINE</b> GAI-13106A/B, GAI-13136A/B .....	1568-2
<b>ZENITH</b> Chassis 19GC50, 19GC50Z .....	1571-2
Remote Control Receiver 9-127-02, Transmitter 124-8 .....	1571-2-A

**Perform a  
death-defying  
act.**

**Have your  
blood pressure  
checked.**

Give Heart Fund





# catalogs literature

Circle appropriate number on Reader Service Card.

**100. Jensen Tools and Alloys**—offers a free 112-page tool catalog describing over 2,500 individual items. Sections include hand tools, power tools, metalworking tools, soldering equipment, optical equipment, test equipment, and electronic chemicals. Also featured is a solder section.

**101. Channel Master**—has available a UHF antenna catalog. Nine UHF antenna types designed for color TV are described and illustrated. Sixteen models are shown, plus various special designs and combinations. The brochure covers antennas for every type of reception area, in all price ranges, and includes performance data.

**102. Hewlett-Packard**—a 32-page brochure—the "Pocket Calculator Buyer's Guide"—describes and gives specifications for the company's full line of preprogrammed and programmable pocket calculators. The free brochure, #5952-6062D, also includes a complete listing of HP pocket-calculator accessories, support literature and prerecorded programs.

**103. Audiovox**—offers a free speaker application chart. The three-color specially-coded chart unfolds into a 17" X 21" poster for easy interpretation. The chart is designed to show the recommended speakers and available locations for import and domestic cars back to 1970. It lists the speaker type, dimensions, kit number and magnet weight of the mini, in-door, in-deck, surface, convertible and coaxial speaker models.

**104. Nortronics Company**—has available the 7th edition of its "Nortronics Recorder Care Manual." It shows step-by-step, illustrated methods for maintenance of recording machines and the proper method for splicing tape. A new feature of the current edition is a revised catalog section of consumer recorder-care products. Also included is a bibliography of helpful

books for those who wish to learn more about tape recording.

**105. Tektronix**—the 48-page catalog number A-3183 contains up-to-date data on new TM500 products, such as the SC502 dual-channel oscilloscope and TM515 Traveler Mainframe. It also contains full specifications on the more than 30 TM500 plug-in modular instruments, and features thirteen articles discussing instrumentation technology.

**106. Hickok**—has a free 16-page catalog describing its full line of portable and bench test instruments. Products covered include single- and dual-trace oscilloscopes, a digital multimeter, a function generator, a curve tracer, FET multimeters, semiconductor testers, color-bar generators, tube testers, a CRT tester/rejuvenator, and a sweep-and-marker alignment generator. Features, operating data, and complete specifications are given for each unit.

**107. Cleveland Institute of Electronics**—offers a 40-page, four-color catalog covering independent home-study courses, and containing a 24-page section which details each of CIE's 13 electronics-training programs. Each course is outlined with course objective and listing of subjects covered. Other departments include: information about career opportunities in electronics; facts on CIE's background and school/student relationship; and an outline of the school's employment assistance program.

**108. Shure Brothers**—expanded and updated catalog of Shure professional products for broadcasting, recording, and motion pictures lists Shure microphones, audio components and accessories, and high-fidelity phonograph cartridges. Included in the free catalog are specifications and individual performance profiles, as well as data about installation.

## FREE ALARM CATALOG

Huge selection of burglar & fire systems, supplies. Motion detectors, infrared beams, controls, door switches, bells, sirens. 500 items, 99 pp. packed with technical details, notes.

(Outside U.S., send \$1.00.)  
 mountain west alarm  
 4215 n. 16th st., phoenix, az. 85016

For More Details Circle (22) on Reply Card

## T & T VALUE SALE

RAYTHEON, I. C. C., RCA, SYLVANIA, EMERSON, DUMONT

### FAMOUS MAKE NEW JOBBER BOXED TUBES

#### 80% OFF LIST

<input type="checkbox"/> 1V2	5 for \$3.20	<input type="checkbox"/> 6HQ5	5 for \$6.75
<input type="checkbox"/> 2AV2	5 for \$4.20	<input type="checkbox"/> 6HV5	5 for \$11.80
<input type="checkbox"/> 3A3	5 for \$5.35	<input type="checkbox"/> 6JC6	5 for \$5.95
<input type="checkbox"/> 3AT2	5 for \$5.20	<input type="checkbox"/> 6JE6	5 for \$11.15
<input type="checkbox"/> 3GK5	5 for \$5.15	<input type="checkbox"/> 6JS6	5 for \$9.90
<input type="checkbox"/> 3HA5	5 for \$5.10	<input type="checkbox"/> 6JH8	5 for \$5.90
<input type="checkbox"/> 3HM5	5 for \$5.10	<input type="checkbox"/> 6KA8	5 for \$6.50
<input type="checkbox"/> 5GH8	5 for \$6.25	<input type="checkbox"/> 6K8	5 for \$8.15
<input type="checkbox"/> 6BK4	5 for \$9.95	<input type="checkbox"/> 6KT8	5 for \$7.25
<input type="checkbox"/> 6CG3	5 for \$5.25	<input type="checkbox"/> 6KZ8	5 for \$5.25
<input type="checkbox"/> 6CJ3	5 for \$5.00	<input type="checkbox"/> 6LB6	5 for \$10.75
<input type="checkbox"/> 6DW4	5 for \$5.00	<input type="checkbox"/> 6L06	5 for \$11.15
<input type="checkbox"/> 6EA8	5 for \$5.25	<input type="checkbox"/> 6F07	5 for \$4.05
<input type="checkbox"/> 6EH7	5 for \$5.10	<input type="checkbox"/> 12BY7	5 for \$7.00
<input type="checkbox"/> 6EJ7	5 for \$4.75	<input type="checkbox"/> 12GN7	5 for \$7.40
<input type="checkbox"/> 6FQ7	5 for \$4.05	<input type="checkbox"/> 17JZ8	5 for \$4.75
<input type="checkbox"/> 6GF7	5 for \$7.05	<input type="checkbox"/> 23Z9	5 for \$6.35
<input type="checkbox"/> 6GH8	5 for \$4.20	<input type="checkbox"/> 33GY7	5 for \$8.05
<input type="checkbox"/> 6GJ7	5 for \$3.70	<input type="checkbox"/> 36MC6	5 for \$11.40
<input type="checkbox"/> 6GU7	5 for \$5.55	<input type="checkbox"/> 38HE7	5 for \$9.75
<input type="checkbox"/> 6HA5	5 for \$5.10	<input type="checkbox"/> 38KH7	5 for \$9.55

Write in Unadvertised Tubes at 80% Off List.

All Prepaid Orders of 100 Tubes or More

in SLEEVES ONLY Take 80% & 10% Off List.

\*SPECIAL 100 6GH8 Tubes ..... \$69.00\*

200 6GH8 Tubes ..... \$118.00\*

### SYLVANIA TUBES NEW FACTORY BOXED 70% & 10%

#### OFF LIST ON ENTIRE LINE IN SLEEVES ONLY

<input type="checkbox"/> 3A3	5 for \$7.22	<input type="checkbox"/> 6L06	5 for \$15.05
<input type="checkbox"/> 6BK4	5 for \$13.43	<input type="checkbox"/> 6LR6	5 for \$13.84
<input type="checkbox"/> 6CJ3	5 for \$6.75	<input type="checkbox"/> 17JZ8	5 for \$6.41
<input type="checkbox"/> 6FQ7	5 for \$5.47	<input type="checkbox"/> 21LU8	5 for \$8.37
<input type="checkbox"/> 6GH8	5 for \$5.67	<input type="checkbox"/> 23Z9	5 for \$8.57
<input type="checkbox"/> 6HA5	5 for \$6.89	<input type="checkbox"/> 35LR6	5 for \$13.84
<input type="checkbox"/> 6LB6	5 for \$14.51	<input type="checkbox"/> 42KN6	5 for \$12.36
<input type="checkbox"/> *SPECIAL—100 6GH8 Tubes	.....		\$105.00*

### TRANSISTORS EQUIVALENT UP TO 90% OFF LIST

SK	ECG	SK	ECG
<input type="checkbox"/> 3018-108	.10 for \$3.38	<input type="checkbox"/> 3103-157	10 for \$4.50
<input type="checkbox"/> 3039-108	.10 for \$3.30	<input type="checkbox"/> 3114-159	10 for \$3.60
<input type="checkbox"/> 3041-152	.10 for \$6.30	<input type="checkbox"/> 3115-165	10 for \$15.00
<input type="checkbox"/> 3052-155	.10 for \$5.85	<input type="checkbox"/> 3124-123A	10 for \$3.15
<input type="checkbox"/> 3054-196	.10 for \$6.75	<input type="checkbox"/> 3132	10 for \$3.90
<input type="checkbox"/> 3083-185	.10 for \$6.30	<input type="checkbox"/> Hep 707	10 for \$15.00
<input type="checkbox"/> 3084-196	.10 for \$4.50	<input type="checkbox"/> Hep 740	10 for \$15.00

### IC'S ZENITH EQUIVALENT

<input type="checkbox"/> 221-31	15 for \$5.00	<input type="checkbox"/> 221-48	5 for \$5.00
<input type="checkbox"/> 221-32	15 for \$5.00	<input type="checkbox"/> 221-51	5 for \$5.00
<input type="checkbox"/> 221-34	5 for \$5.00	<input type="checkbox"/> 221-52	5 for \$5.00
<input type="checkbox"/> 221-42	5 for \$5.00	<input type="checkbox"/> 221-62	5 for \$5.00
<input type="checkbox"/> 221-45	5 for \$5.00	<input type="checkbox"/> 221-65	5 for \$5.00
<input type="checkbox"/> 221-46	5 for \$5.00	<input type="checkbox"/> 221-79	5 for \$5.00

### YOKES

<input type="checkbox"/> Y130	<input type="checkbox"/> Y94	<input type="checkbox"/> Y105	
<input type="checkbox"/> 95-2779	ea. \$5.95		5 for \$25.00
<input type="checkbox"/> Y110	<input type="checkbox"/> Y162/Y132	<input type="checkbox"/> Y137	
<input type="checkbox"/> Y147	ea. \$9.95		5 for \$40.00

### DIODES, RECTIFIERS EQUIVALENT

RCA Dumper Diode Equip. To:			
<input type="checkbox"/> RCA 120818	\$1.00	<input type="checkbox"/> RCA 135932	\$2.00
<input type="checkbox"/> 6500 PIV Color Focus Rectifiers			10 for \$5.00
<input type="checkbox"/> 2.5 Amp 1000 PIV IR-170			100 for \$8.95
<input type="checkbox"/> Syl. Voltage Tripler Repl. 32-29778-3			ea. \$9.95

### AUDIO, CARTRIDGES, NEEDLES, SPEAKERS REPL.

<input type="checkbox"/> N44	<input type="checkbox"/> N75	<input type="checkbox"/> N77	<input type="checkbox"/> N91
<input type="checkbox"/> V15	ea. \$2.95		10 for \$25.00
<input type="checkbox"/> N3-70 Needle			10 for \$10.00
<input type="checkbox"/> Astatic Cart. 142			8 for \$10.00
<input type="checkbox"/> Telrad Assorted			5 for \$10.00
<input type="checkbox"/> GE 650 Cart			3 for \$10.00
<input type="checkbox"/> EV5015			5 for \$10.00

### ANTENNAS

<input type="checkbox"/> 72 ohm to 300 ohm Matching Transformer	10 for \$5.95
<input type="checkbox"/> 59J "F" Connectors	100 for \$7.00
<input type="checkbox"/> 300 ohm 2 set Coupler CO 12	5 for \$7.50
<input type="checkbox"/> 72 ohm to 300 ohm Signal Splitters	5 for \$8.50
<input type="checkbox"/> 72 ohm 2 set Coupler	10 for \$10.00
<input type="checkbox"/> 72 ohm 3 set Coupler	10 for \$20.00

### GENERAL

<input type="checkbox"/> 19" & 25" 21" Color Boosters	3 for \$11.95
<input type="checkbox"/> 4 Asst. Tuners New	\$15.00
<input type="checkbox"/> 4 Asst. New Color Tuners	\$25.00
<input type="checkbox"/> 20 Asst. Belts (Dealer Price Net \$70.00) Your Cost	\$7.00
<input type="checkbox"/> 25 Ft. Stereo Extension Cord	10 for \$14.95
<input type="checkbox"/> 60 minute Irish cassette tapes	12 for \$6.00
<input type="checkbox"/> 90 minute Norelco type boxed	10 for \$10.00
<input type="checkbox"/> 84 minute Irish 8-track tape	6 for \$6.00
<input type="checkbox"/> 84 minute Shamrock 8-track tape	7 for \$6.00
<input type="checkbox"/> 40 minute Shamrock 8-track tape	7 for \$5.00
<input type="checkbox"/> 5 x 7 Speaker Kit	\$2.95
<input type="checkbox"/> 21" Speaker Enclosures inc. speaker	\$29.95 pr.

• LETTERS OF CREDIT AND ALL CHECKS PLACED ON DEPOSIT WITH MANUFACTURERS HANOVER TRUST BANK, N. Y. C.

• MASTER CHARGE ACCEPTED MINIMUM \$100.00

• MINIMUM ORDER \$60.00 FOB BROOKLYN, N. Y.

• CATALOGS, \$1 REFUNDABLE UPON YOUR ORDER

• C. O. D. 5% DEPOSIT—CASH ONLY

• SEND CHECK OR MONEY ORDERS TO:

## T & T SALES CO.

4802 AVENUE K  
 BROOKLYN, N. Y. 11234

Phone: (212) 241-5940

# The MARKETPLACE

This classified section is available to electronic technicians and owners or managers of service shops who have for sale surplus supplies and equipment or who are seeking employment or recruiting employees.

Advertising rates in the Classified Section are 35 cents per word, each insertion, and must be accompanied by cash to insure publication.

Each initial or abbreviation counts a full word.

Minimum classified charge \$3.00.

For ads on which replies are sent to us for forwarding (blind ads), there is an additional charge of \$3.00 per insertion to cover department number, processing of replies, and mailing costs.

Classified columns are not open to advertising of any products regularly produced by manufacturers unless used and no longer owned by the manufacturer or a distributor.

## FOR SALE

**ADVERTISING PACKAGE FOR TV service shops.** Inexpensive eye catching ads contain personal message from you-build customer confidence. Keeps your name before the public weekly. **PROVEN RESULTS.** Thirty ads with instructions \$19.95. Sample \$1.00 refundable. TV TIPS, 430 South Jefferson, Lebanon, Mo. 65536. 11-75-81

**NEW Canadian Magazine "Electronics Workshop".** \$5.00 yearly. Sample \$1.00. Ethko, Box 741, Montreal "A" Canada. 10-75-121

**CONVERT any transistorized T.V. tuner to a tuner substituter.** Plans \$2.00. New accelerated Radio & T.V. course. **RADIO TELEVISION TRAINING,** Box 279, ES-36, Syracuse, N.Y. 13206. 8-75-11

**TEKTRONIX SCOPES—Hewlett-Packard generators, other test and electronic equipment parts, tubes, "ham" supplies, surplus, and older parts. ELECTRONIC SPECIALTIES, 1659 W. Wetmore, Tucson, Az. 85705. (602) 887-9729. 1-76-121**

**COLOR-BAR Generator 16 patterns, pocket size. CMOS-LS1 chip, one transistor. Complete plans \$5.00. Workshop, Box 393, Bethpage, N.Y. 11714. 4-76-21**

**REJUVENATE TV Picture Tubes without expensive equipment. Use power from TV & Clip leads, \$5.00 to W. R. Collins, HQ 4 TC BDE, APO NY 09451. 4-76-11**

**COLOR TELEPHONES—New American made with one year warranty. Free information or send \$1. for color digest and prices. Telectra Sales, Box 9218-ES, Richmond, VA. 23227. 2-76-31**

**SENCORE: FE160 Multimeter—169.00. FE21 Portable Multimeter—119.00. TF166 Transistor Analyzer—159.00. Heathkit 10-103 Oscilloscope—289.00. Eico 379 Generator—99.00. 150 Tracer—89.00. 710 Grid Dip—59.00. SWTPC Function Generator—45.00. Sprague T06A Capacitor Analyzer—139.00. All equipment used only once for performance test. Zupan, Box 302, Mineola, NY 11501. 4-76-11**

## FOR SALE (CONT.)

**STOP...don't junk that television set. ASE manufacturers the world's most complete line of television picture tubes. No other company offers: Over 1700 types of television picture tubes. Most types immediate delivery. Transportation in the Midwest—paid, 1/2 transportation paid in other states. Tubes for Old or New Models. Complete line of both black & white and color. Full 2 year factory warranty. Lowest prices anywhere. Finest quality. Write today for more information. Allied Sales & Engineering, Inc., Dept. 27, Pimento, Ind. 47866. Telephone - 812-495-6555. 4-76-21**

**TV SALES & Service in same location 15 years. Retiring. Net over \$25,000 per year. \$25,000, including truck. A. Bolin, 6361 Balsam Lake, San Diego, Ca. 92119. 4-76-11**

**CONVERT any transistorized TV tuner to a tuner substituter. Plans \$2.00. New accelerated Radio & TV course. RADIO TELEVISION TRAINING, Box 279, ES-46, Syracuse, N.Y. 13206. 8-75-11**

**TELEVISION PARTS and Equipment. Ideal for Starting New Business. Joe Singley, 728 Mt. Evans St., Longmont, Colorado 80501. 4-76-11**

**SALE OR TRADE: Photofacts to 1036. Send SASE: Tom Hughes, Box 3025, Westford, Ma. 01886. 4-76-11**

## EDUCATION-INSTRUCTION

**REPAIR TV TUNERS—High Earnings; Complete Course Details, 12 Repair Tricks, Many Plans, Two Lessons, all for \$2. Refundable. Frank Bocek, Box 3236 Enterprise, Redding, Calif. 96001. 4-76-41**

**TV PROBLEMS???** Send symptoms with a copy of schematic and self-addressed stamped envelope and \$2.00, to Troubleshooter, Box 4553, Downey, Ca. 90241. Results Guaranteed. 9-75-11

## BUSINESS OPPORTUNITY

**DEALER INQUIRIES invited. Add color telephones and accessories to your sales. Send for additional information on business letterhead. Telectra Sales, Box 9218-ES, Richmond, VA. 23227. 2-76-31**

**TV SHOPS—Needed to repair and update master antenna systems with new patented method. I will train you. No competition. You will be one of a select number directly under my technical assistance by WATS telephone. Send resume and credit references: Melvin Cohen, Television Broadcast Engineer, May Company Building, 3651 Prospect Avenue, Riviera Beach, Fla. 33404. Enclose 13 cents addressed envelope. Be patient for my reply. 11-75-61**

**INCREASE SERVICE PROFITS—Avoid consumer problems. Business Manual tells how. Contract Manual shows how to get paid before you service and hold customers. Either book \$15.00, both \$25.00. NATESA, 5908 S. Troy, Chicago 60629. 2-76-31**

**TV SHOPS: Qualify for my telephone assistance to solve your "Tough Dog" TV repairs that waste bench space. Send resume and credit references: Melvin Cohen, Television Broadcast Engineer, May Company Building, 3651 Prospect Avenue, Riviera Beach, Fla. 33404. Enclose 13 cent addressed envelope. Be patient for my reply. 3-76-21**

**CALIFORNIA BOUND? Take over established TV/HiFi shop on easy terms. Nets \$20,000+. Box 157, Palo Alto, 94301. (415) 327-5320. 3-76-31**

**TV—STEREO TECHS. Send name for FREE copy TV Service Newsletter, current time-saving case histories & money-making ideas. Electronic Publishing Co., 617 E. 13th Ave., Denver, CO 80203. 4-76-11**

## WANTED

**WANTED—DEFLECTION BOARD for Sony Model TV4-203, part number 538176-12. Call collect 717/299-3671, Extension 349, Mr. Reid. 4-76-11**

**CLEAN YOUR SHOP: All those used schematics diagrams and service manuals, (Rider's, Sam's Photofacts, Sam's Specialized series, or any other brand). That you do not need anymore, Send them to Ing. Montes, Juan Alvarez, 1115 Guadalajara, Jalisco, Mexico....and I will send you Beautiful Mexican gifts. 4-76-11**

**ANTIQU—Needed 1926-1938 Radio diagrams, \$7. Later volumes \$4 each. Lawrence Beitman, 409-E Chalmers, Champaign, Illinois 61820. 4-76-11**

## advertisers' index

American Technology Corporation	11
Arrow Fastener Co., Inc.	51
B & K Div., Dynascan Corp.	12, 13
Bussmann Mfg. Div., McGraw-Edison	Cover 3
Castle Electronics, Inc.	Cover 4
Cost Effective Components	50
Dana Laboratories, Inc.	11
Enterprise Development Corp.	53
General Electric Company	10
Jensen Tools and Alloys	48
Mallory Distributor Products, Inc.	3
Mountain West Alarm Supply Co.	55
NikoITronix Electronics	43
Non-Linear Systems	25
Panasonic Consumer Parts	7
Perma-Power Company	49
Precision Tuner Service	Cover 2
Projector-Recorder Belt Co.	53
RCA Distributor and Special Products	32 & 33, 36 & 37
Raytheon	1
Sperry Tech. Inc.	25
GTE Sylvia - Consumer Renewal	17, 18
T & T Sales Company	55
Telematic	52
Tuner Service Corporation	5
Winegard Company	23

Note!

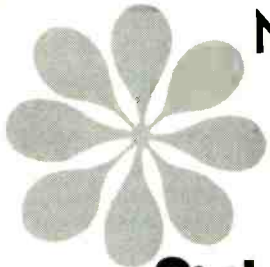

Birth defects are forever. Unless you help.



MARCH OF DIMES

THIS SPACE CONTRIBUTED BY THE PUBLISHER



# Buss® Fuses Specialize Too!

*in the protection of*

# C B

## EQUIPMENT

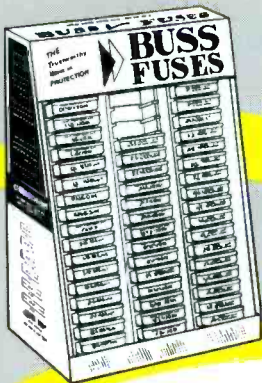
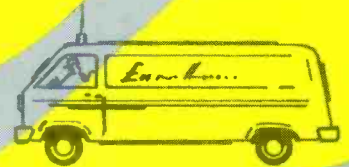
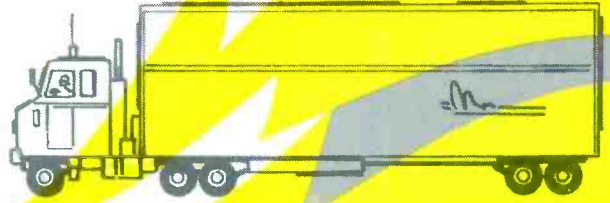

No. 240CB-3  
Metal Display Stand

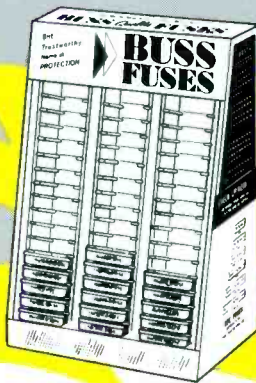

No. 80CB-1  
Metal Display Stand

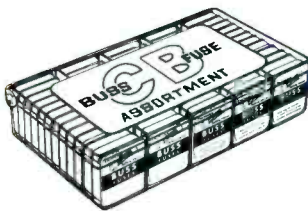

No. 240CB-4  
Plastic Display Box

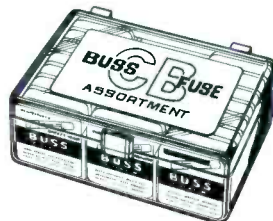

No. 80CB-2  
Plastic Display Box

Now . . . four new BUSS-fuse assortments exclusively designed with replacement fuses to service most Citizen Band Radios — offering a whole new area of opportunities for increased profits.

Two assortments contain 48 — 5 in metal boxes (240 fuses). BUSS No. 240CB-3 fuse assortment comes in a handy metal display stand. BUSS No. 240CB-4 fuse assortment is packed in a compact plastic display box.

In addition, there are two fuse assortments containing 16 — 5 in metal boxes (80 fuses). BUSS No. 80CB-1 fuse assortment packed in a metal display stand and BUSS No. 80CB-2 fuse assortment in a plastic display box.

Both BUSS fuse assortments contain a careful selection of the most popular fuses used in CB radios.

CB dealers can now have the fuses they need in a neat complete package to service all their customers fuse needs.

For full fuse assortment details, write for BUSS Bulletin CBA.



BUSSMANN MANUFACTURING  
a McGraw-Edison Company Division  
St. Louis, Missouri 63107



A question for the professional TV Service Technician

## ***What is the signal NOW?***

After all the amplifying, levelling, compensating and distributing . . . is it what it is supposed to be?

You are a professional TV Service Technician . . . and see this "wire coming out of the wall" all the time. Maybe you assume that the signal is O.K. . . . *but do you know?*

**Now you can put an end to your guessing about the signal level.**

**Here is a field strength meter designed exclusively for you . . . at the right price!**

# **MEZZER™**

## **Model TVS**

***service dealer net \$69.95***

- Simple to operate, minimum of operating adjustments.
- Principle of operation similar to output meter and attenuator system of expensive signal generators.
- Standard signal level for proper color reception (1mV to 4mV — 0dBmV to + 12 dBmV) clearly indicated for instant identification.
- Measures signals from 300uV to 30,000uV.
- Uses ordinary 9v transistor batteries, low current consumption ensures low cost per measurement.
- IC amplifier and meter driver circuits.
- Electronic voltage regulation.
- Quasi-peak detector.
- LED/IC battery status system, shows when batteries are below operating voltage.
- Sturdy, high impact ABS plastic case for field use.
- Made in USA.



Castle products — advanced technology — modern styling — and they work!

See your stocking distributor . . . or write for more details and complete specifications.

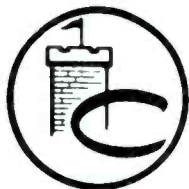

**CASTLE ELECTRONICS, INC.** 5701 N. Western Ave., Chicago, Ill. 60645 • Ph. (312) 728-1800

In Canada: Len Finkler Ltd., Ontario

For More Details Circle (3) on Reply Card